

RESIDENTS FIRE SAFETY INFORMATION PACK



**JOHN KENNEDY HOUSE
ROTHERHITHE NEW ROAD
LONDON
SE16**

THE CONTENTS OF YOUR PACK

<u>Section</u>	<u>Page No.</u>	
1.	3.	Introduction Here we will explain the purpose of the Fire Safety Information Pack and why it is important that you read the contents.
2.	4.	Your Escape Routes We have provided specific information on how to make your way out of your home and block to a place of safety away from the building.
3.	11.	Your Block & Your Home – John Kennedy House We have provided information within this section of the Fire Safety measures that you can find within your block and within your home.
4.	20.	Advice on what to do and what not to do No information pack would be complete without a Do's and Don'ts section. We have given some examples of potentially harmful practices that are common in a lot of blocks.
5.	23.	Contacts This last section will give you information on who to call for advice or to report a Fire Safety issue.

RESIDENTS FIRE SAFETY INFORMATION PACK

Section 1 - The Introduction

This Resident Fire Safety Information Pack contains some extremely valuable information relating to the Fire Safety measures both in your block and within your home. We encourage you to take time to read all the contents.

The purpose of producing this Pack is to provide you with as much information as possible in helping you become more aware of the various Fire Safety measures that exist within your block and within your home. We have also provided information on measures that you can adopt to ensure that yourself, your family and your neighbours are kept safe and secure and are aware of what you need to do in the event of a fire in the building.

We have included information on Fire Safety measures within your home. This includes your detection systems, fire doors and escape routes. We explain what the hazards are within your home and tips on checks you can make to reduce the risk of a fire breaking out.

You will also find information on your block including the equipment and construction materials that exist to ensure that if a fire does break out it is contained in the area where it started. If you need to evacuate the building we have provided detailed instructions of your escape route(s) in both graphic and text formats.

Not everyone takes Fire Safety seriously and we have added examples of hazardous practices that could hamper residents needing to escape and emergency services trying to fight a fire and assist evacuation.

If you require any further information on issues regarding Fire Safety we have included a number of contacts that you can call or email who will help you with any query you may have.

Southwark Council have an in-house Fire Safety Team with a primary role to carry out Fire Risk Assessments (FRAs). These involve visiting buildings and assessing various aspects of Fire Safety, possible sources of fire and checking escape routes. FRAs are required to cover the communal areas in a block and not the inside of each individual property. The Fire Risk Assessment is updated and reviewed as part of a programme of inspection dependant on the overall risk.

The Southwark Fire Safety Team also advise, assist and train Southwark staff, residents and attend evening tenant and residents meetings when required.

The Southwark Fire Safety Team work closely with the London Fire Brigade to ensure compliance is being met across the Southwark stock.

RESIDENTS FIRE SAFETY INFORMATION PACK

Section 2 - Your Escape Routes

This block has been built to protect residents in the event of a fire, so do not automatically assume you must leave your flat. The emergency services will decide whether the building needs to be evacuated. If it does, use your front door & stairs (unless the fire/smoke prevents this, in which case use the alternative means of escape). If you have an alternative means of escape this will be mentioned in the next section.

Basic advice:

- Familiarise yourself with the escape route(s) from your flat before an emergency. For most flats this is using the staircase (**NEVER A LIFT**).
- Keep all emergency access routes clear; your life or those of your family and neighbours could be endangered if you do not. Large plants, furniture or other belongings should not be stored on escape routes for this reason.
- If the fire is in your flat:
 - **DO NOT** stay to fight a fire.
 - Evacuate everyone from the flat.
 - Close all doors behind you.
 - Call the Fire Brigade (999) when safely away from the building and when it is safe to do so.
- If you detect a fire in another part of the building:
 - Stay in your flat unless evacuated by the emergency services.
 - Call the Fire Brigade (999).
 - **DO NOT** tackle the fire yourself.
 - Close all doors & windows to restrict the spread of smoke.
 - If you become affected by heat or smoke, leave your flat, as described above.
 - **IF IN DOUBT GET OUT!!!**

Your Escape Routes

If, and only if, fire and smoke is affecting you or your home, you should evacuate the premises immediately. Make your way to the stairwell as soon as possible, exit the building and remain a safe distance from the fire/building. Never attempt to use the lift if you are aware that there is a fire in the building.

Your home has been designed with two means of escape in the event of a fire occurring, as pictured below. This will depend on where you are positioned in the block. There are two property types, Type 1 has the front entrance door downstairs and an alternative exit door upstairs (Floors 6-14), Type 2 has the front entrance/exit door only located downstairs. You can identify which flat type you live by the position of the front entrance door & alternative exit door.

Please have a look at the floor plans on the following pages and identify your property type. Then, follow the directions on the plan so that you are aware of your escape route.

The Exits from your home should look similar to the photographs below:

EXIT 1 = from your front entrance door (ground floor of flats).

EXIT 2 = from the alternative exit door (upper floor) to the communal corridor or flat roof area.

EXIT 1

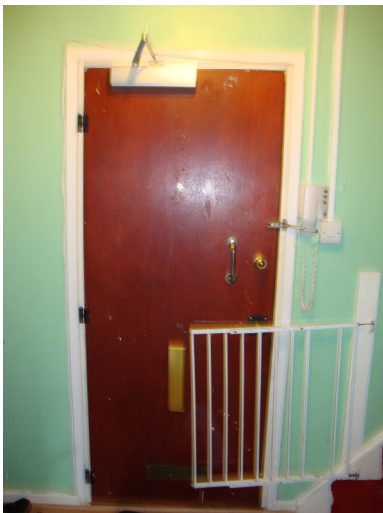

EXIT 2



TYPE 1 Maisonette

EXIT 1

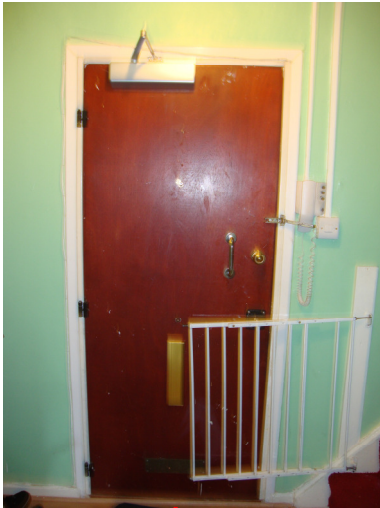

EXIT 2

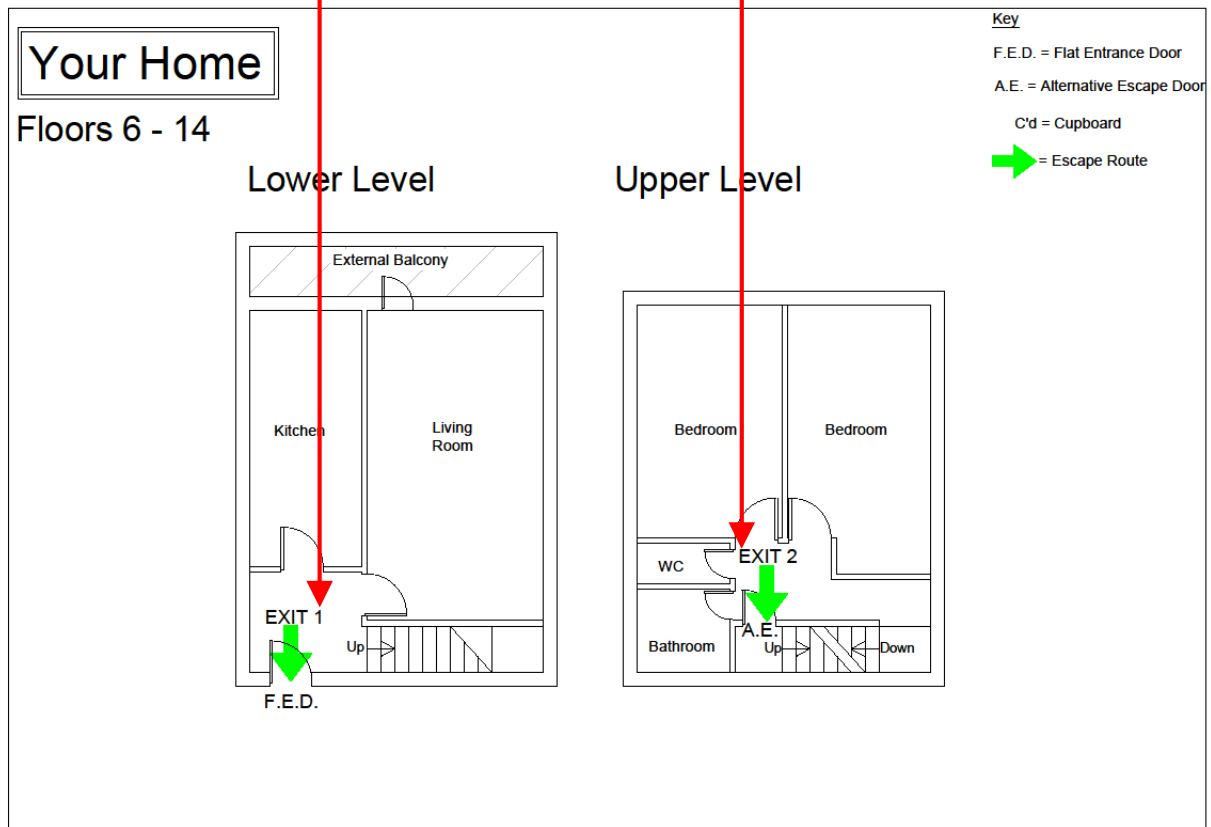

TYPE 1 MAISONETTE (Located on Floors 6 - 14)

In the majority of cases your main exit from your home in the event of an evacuation is by the front entrance door (downstairs). However, if the fire is in your home or the front door is not accessible then you have an alternative. You can evacuate your home from the alternative Fire Door Exit located upstairs. This will let you through to the corridor or the flat roof area where you can follow the signs to the stairwell and to a place of safety.

The plan of your escape routes can be seen above and on the following pages.

These escape routes are vitally important to your safety. They should be kept clear at all times and not obstructed.

TYPE 2 MAISONETTE

EXIT 1

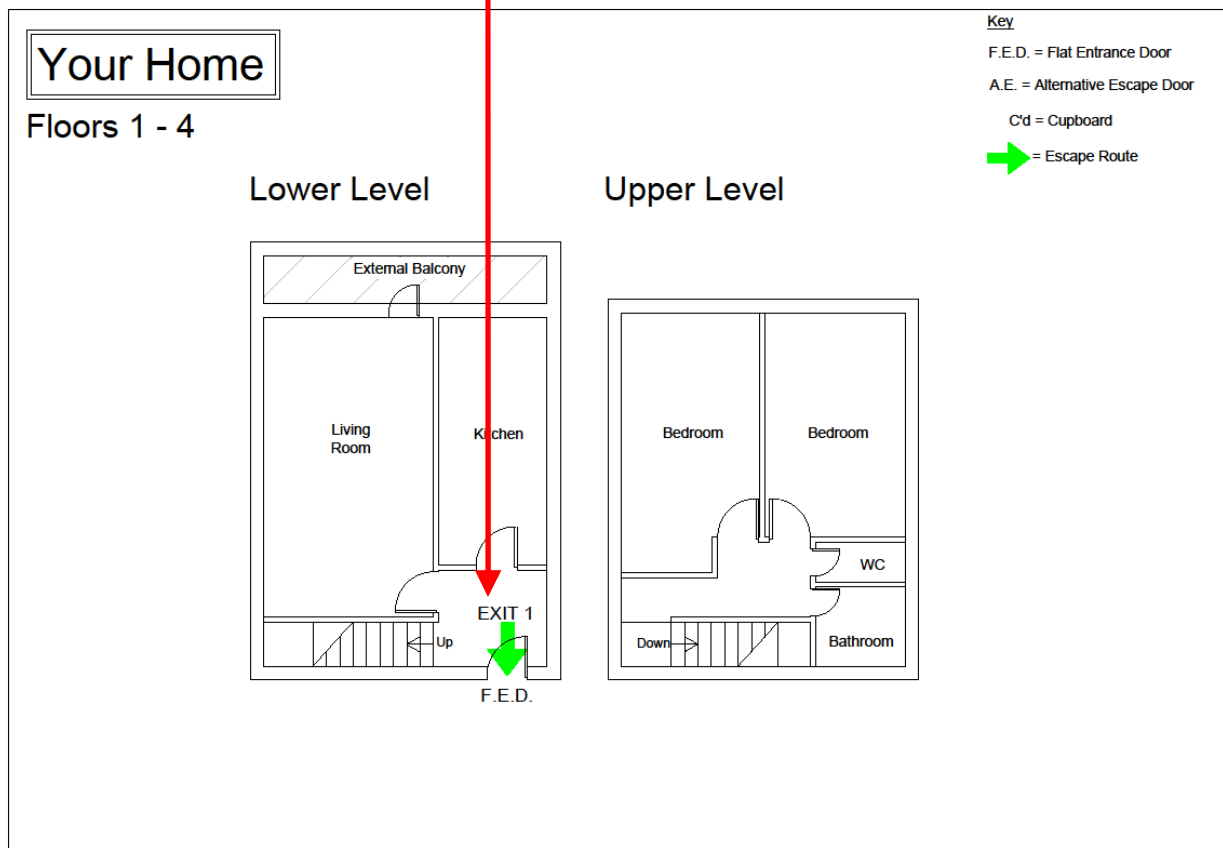

TYPE 2 MAISONETTE (Located on Floors 1 - 4)

Your main exit from your home in the event of an evacuation is by the front entrance door. This will let you through to the corridor where you can follow the signs to the stairwell and to a place of safety.

The plan of your escape routes can be seen above and on the following pages.

These escape routes are vitally important to your safety. They should be kept clear at all times and not obstructed.

Even Floors (Floors 6 – 14)

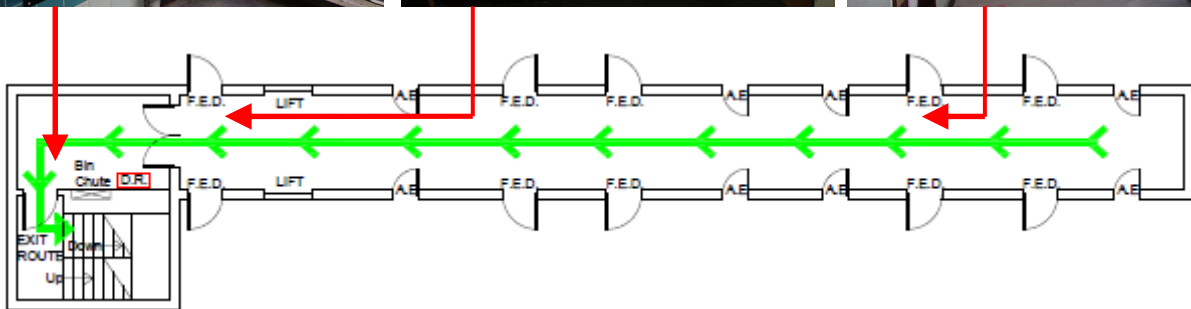

Even Floors (Floors 1 - 4)

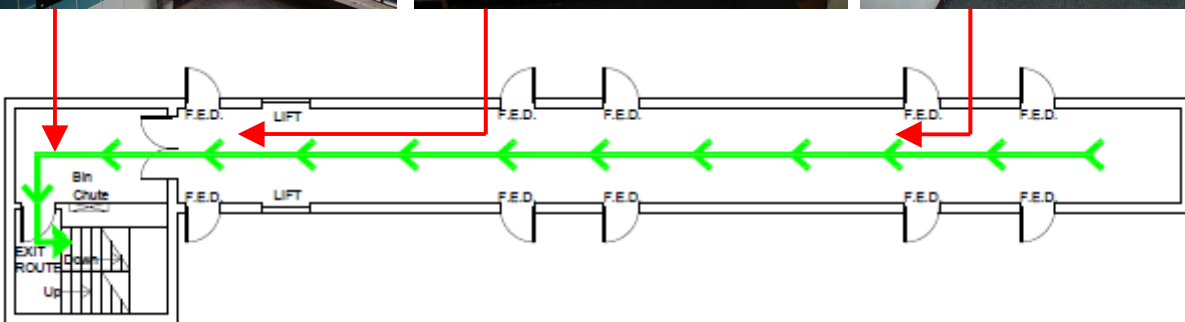

Ground Floor Level

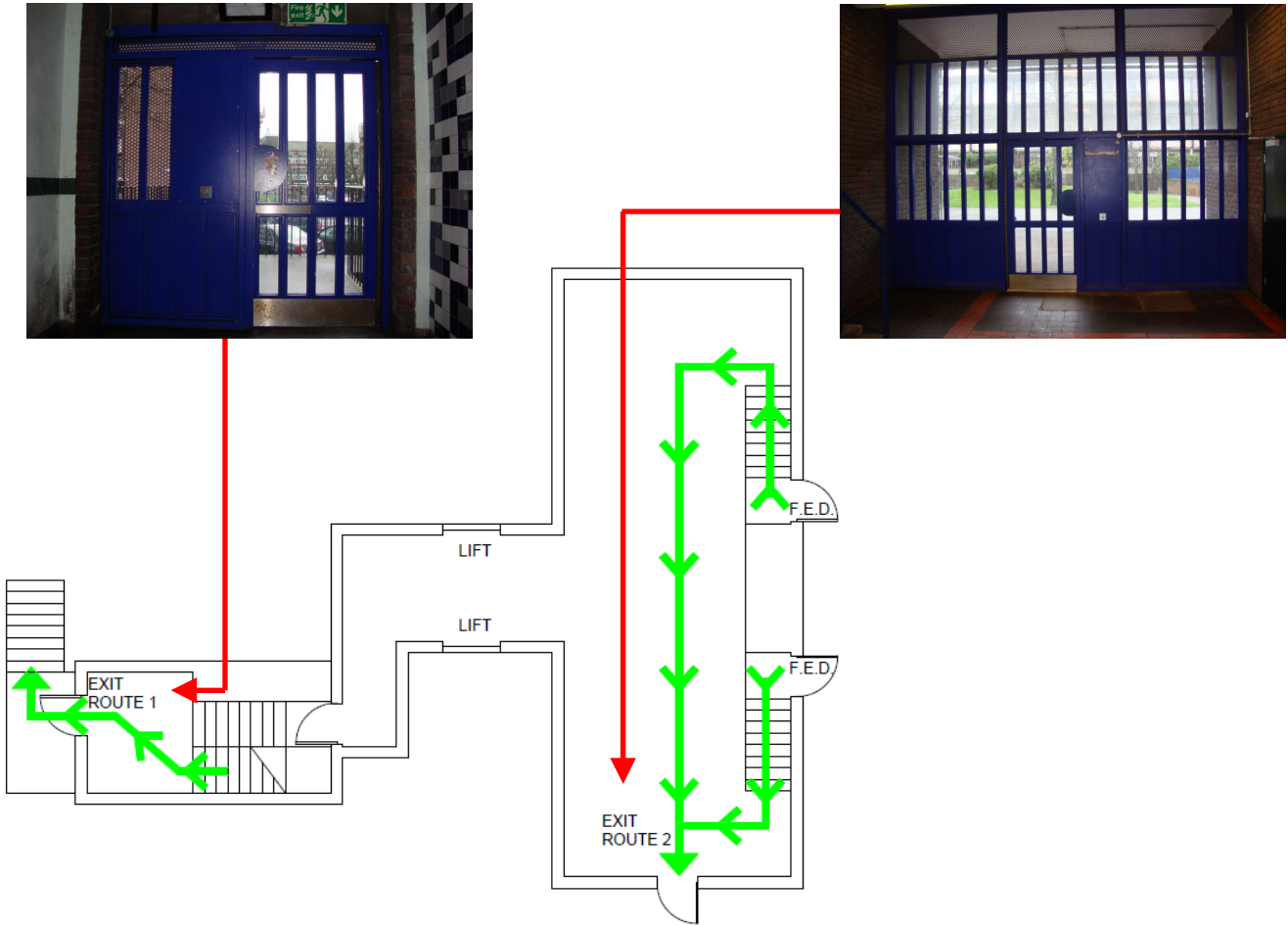

Following the stairwell, you will come to an exit at the bottom of the stairwell (Exit Route 1). This will lead you to the front of the building and to a place of safety.
If you continue through the stairwell you will find yourself in the entrance lobby where you can exit through the main entrance door to the front (Exit Route 2) and to a place of safety (see plan above).

RESIDENTS FIRE SAFETY INFORMATION PACK

Section 3 - Your Block and Your Home

Your Home

Your home was designed as a fire compartment. This means that all four walls, the ceiling and floor were constructed to provide at least 60 minutes protection from fire and smoke. Unless a fire starts in your home it should remain unaffected by smoke or fire for at least 60 minutes during which time the emergency services will either deal with the fire or instruct you to leave your home. If a fire starts within your home it should be contained there for the same length of time. **You however should evacuate immediately.** Some of the Fire Safety Measures in your home are detailed below.

Detection/Warning	<p>Mains powered automatic smoke detectors with battery back up are installed within your home. In kitchens a heat detector rather than a smoke detector is installed. Heat detectors are installed in kitchens to reduce the number of 'false alarms' caused by frying, grilling or toasting food.</p> <p>Detectors should be interlinked so that if one detector is triggered, the alarm sounds in each & every alarm location. Remember to test your alarm on a weekly basis.</p>
--------------------------	---



Flat Entrance Door	<p>Your Flat Entrance Door (FED) is a fire door. It is self-closing and has strips and seals that will prevent smoke and flames from entering the protected escape route if your flat is on fire. It will also prevent smoke and flames from entering your flat from the Protected Escape Route. It is therefore vitally important that if you have to leave your flat as a result of a fire that you ensure the door latches shut behind you.</p> <p>In addition, DO NOT make alterations to your door such as fitting extra locks and cat flaps, as this will compromise your safety.</p>
---------------------------	---



Internal Doors	<p>Some of the internal doors to rooms in your home may also have some fire resistance. The doors have a solid core and can be recognised by smoke seals in the edges of the door that will expand in a fire and seal the door into the frame. An example of these seals can be seen below. It is recommended that when you leave your home for any length of time and when going to bed for the night that you ensure these doors are latched closed.</p> <p>It is again important that you DO NOT make alterations to the door such as additional locks and cat flaps, as this will compromise your safety.</p>
-----------------------	--

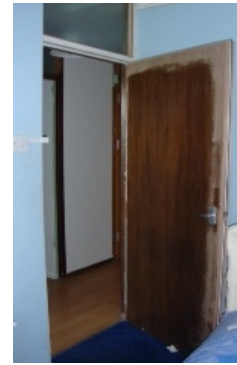

RESIDENTS FIRE SAFETY INFORMATION PACK

Your Block

Your block contains many safety measures that have been introduced both when the block was built and also in the years up to the present day. You may be aware of these measures but we are sure many of you may not be. This section intends to let you know what these measures are and the role they play in protecting residents from the effects of fire and smoke.

Emergency Lighting	<p>These are lights that are provided in the protected escape routes and in the event of the electricity failing they will stay lit and guide you along the escape route and out of the building.</p> <p>Generally there are two types of emergency lighting. Some will not normally be lit but will have a small green or red light that indicates they are working. If the electricity fails they will illuminate. The other type remains lit and are on a protected circuit so even if the electricity is cut they will remain lit.</p>
---------------------------	--



Dry Risers	<p>A Dry Riser is used by the Fire Brigade to get water to the floors of high rise blocks. On the ground floor there is a Dry Riser Inlet that the Fire Brigade connect their hoses to and water is pumped up the vertical pipe to each floor. The fire-fighters connect up to the outlet to fight the fire on each floor.</p> <p>Dry Risers Inlets must have fire engine access within 18 metres of the dry riser inlet so this area must be kept clear at all times.</p>
-------------------	---



Protected Escape Routes

The protected escape routes are designed to allow for residents from all parts of the building to reach the outside without passing through a higher fire risk area. These routes are protected by materials that will provide a minimum of 60 minutes protection from fire and smoke and will enable residents and visitors to reach a place of safety should a fire occur in the block. All walls, floors and ceilings protect the route and generally the only break is doors but these also protect the route as they are fire doors.

It is vitally important that the protected routes be **kept clear** of obstructions & combustible materials so that residents evacuating the building do not trip over bags of rubbish or discarded furniture. In addition, it would be extremely hazardous if any of these items caught fire in the protected escape route making it unusable.

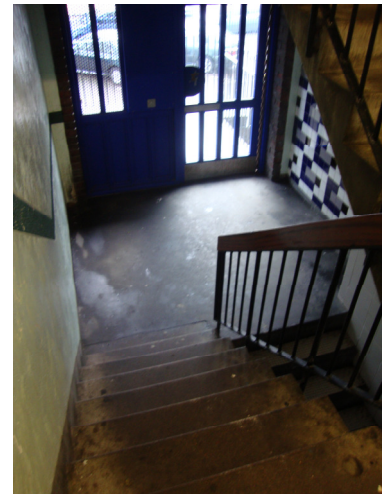

Fire Doors

There is more to fire doors than meets the eye. A fire door is a complete installed door assembly comprising of a doorframe, door leaves, other panels, hardware, seals and any glazing that when closed is intended to resist the passage of fire and smoke. In the closed position, they protect the escape route which enables residents to evacuate.

You will find fire doors on flat entrance doors, across corridors on the escape route and on electrical cupboards. They are there to protect your means of escape and should **NEVER** be wedged/propped open. All fire doors should not be locked or fastened in such a way that means a key is required to make an escape.



Fire Hydrants

Fire Hydrants are found in the ground near your block. They are sometimes painted yellow but also are marked with 'FH' or 'Fire Hydrant'. Near to the hydrant on the wall there is a yellow 'H' plate. The plate indicates the size of the pipe and the distance the hydrant is away from the plate. In the example opposite it can be seen that the hydrant has a 250mm pipe and is 1 metre away from the H plate. They are used by the Fire Brigade to provide a supply of water from the mains to be fed into the Dry Riser Inlet. They are located in public footways or highways.

Obstructing a hydrant is an offence and can carry a fine if convicted. Please remember to park considerately and away from any adjacent hydrants. Hydrant defects relating to leakage or safety must be reported to the local water company (as they are the owners). Any other defects or queries can be reported to the London Fire Brigade's water team.



Fireman's Lift Control

If a fire breaks out in your block and the Fire Brigade are called it is likely that the electricity to the block will be switched off when they arrive. This means that the lift will not be operational. It is imperative that residents do not use the lift when they are aware of a fire as they may become trapped in the lift. The Fire Brigade however can control the lift for their own fire fighting purposes by using the control switch that you will find adjacent to the lift doors. **REMEMBER – NEVER USE THE LIFT IF YOU ARE AWARE OF A FIRE.**



Fire Exit Signs & Fire Action Notices

Fire Exit Signs are designed to identify the means of escape in the event of a fire. These have been strategically positioned throughout the common areas of your block to identify the direction of travel in the event of a fire occurring.

Fire Action Notices are designed to inform the occupants of the block what to do in the event of a fire. These have been strategically positioned throughout the common areas of the block.



ACCESS FOR EMERGENCY SERVICES

The Dry Riser Inlet to your block can be found indicated by the arrow in the picture opposite. Do not obstruct the Dry Riser Inlet or park over the Fire Hydrant below right.



FIRE ACTION NOTICES

The following is a breakdown of the guidance given in the Fire Action Notices and an explanation of what the advice means.

If you discover a FIRE anywhere in the building:

Discovery of a fire can be by:

- sight - seeing fire or smoke
- hearing (sound of burning, sound of alarm - mechanical or verbal)

Anywhere in the building can be:

- your own home or other homes in your block
- communal area cupboards and rooms
- staircase, corridors, etc
- basement or roof
- refuse system – waste chutes and bin chambers
- areas around (or close to) the external areas of the building

1. Raise the alarm by shouting “FIRE FIRE”

Attempt to alert others by shouting but don't expose yourself to danger by trying to make physical contact with neighbours.

2. If you are not in your own home or someone else's home in the building, evacuate the building immediately if it is safe to do so

- Attempt to leave the building by the most direct route that does not expose you to smoke or flames. REMEMBER – KNOW YOUR ESCAPE ROUTES.
- Exit the building and move to a safe distance away. If your route out of the building is blocked by smoke or fire, move away from the fire and seek refuge in a protected area as far away from the fire as possible. A protected area is a place that is free of fire and has at least one substantial wall and door between yourself and the fire. Avoid placing yourself in a confined space.

3. Telephone the Fire Brigade on 999

- Use a mobile phone or landline to contact the Fire Brigade (999), keep calm and follow the operator's instructions. Further advice on calling the Fire Brigade is available at <http://www.fireservice.co.uk/safety/dialling999>
- Remember! 999 emergency calls to the Fire Brigade are free of charge and can be made on a mobile phone that does not have any credit.

RESIDENTS - If the fire is inside your home:

If you are at home and discover a fire in your home

1. Evacuate the building closing your Front Door behind you

- If the fire is behind a closed door do not attempt to open the door and do not attempt to tackle the fire.
- If the door of the room in which there is a fire is open from the outside close the door if safe to do so.
- Alert anyone else inside your home and leave by the nearest exit door of your home (that leads to a route out of the building) closing it shut behind you. **REMEMBER – KNOW YOUR ESCAPE ROUTES.**
- Leave the building by the most direct route.

2. Remain a safe distance from the building and await the Fire Brigade

- A safe distance from the building is a place where you will not be affected by smoke, flames or debris from a developing fire or where you may obstruct the passage of other evacuees or fire fighters.
- When the Fire Brigade arrives, identify yourself as a resident and cooperate with their instructions.

RESIDENTS - If the fire is NOT in your home:

If the fire is in any other part of the building or grounds

1. 'STAY PUT' in your home unless you are directly affected by smoke or fire

Remain in your home unless the internal parts of your home are experiencing smoke or fire. Your home is designed to be a 'fire resistant' box that should offer you resistance against fire or smoke for a reasonable time during which the Fire Brigade will arrive and effect a rescue if necessary. If lots of people try to evacuate the building at the same time (if not under the control of the Fire Brigade) it may cause panic or injury and affect fire fighting or rescue operations.

2. If you are directly affected by smoke or fire - evacuate the building closing your Front Door behind you

- Alert any other people you live with and leave by the nearest exit door of your home (that leads to a route out of the building) closing it shut behind you. **REMEMBER – KNOW YOUR ESCAPE ROUTES.**
- Leave the building by the most direct route.

3. Remain a safe distance from the building and await the Fire Brigade

- A safe distance from the building is a place where you will not be affected by smoke, flames or debris that may emanate from a developing fire or where you may obstruct the passage of other evacuees or fire fighters.

- When the Fire Brigade arrive, identify yourself as a resident and cooperate with their instructions.

If you do evacuate the building

Do not use the lifts

The lifts are not fire proof and may leave you trapped in the lift if the fire causes a power failure.

DO NOT stop to collect personal belongings

Collecting personal belongings will delay your evacuation and carrying belongings may hinder your own and other evacuees escape.

DO NOT re-enter the building until authorised to do so

During a fire fighting and rescue operation the Fire Brigade will take charge of the building. They will inform all evacuees if and when it is safe to re-enter the building. If you re-enter the building before you are authorised by the Fire Brigade you may put yourself in danger and obstruct fire and rescue operations.

RESIDENTS FIRE SAFETY INFORMATION PACK

Section 4 – Advice on what to do and what to avoid

General Advice for Fire Prevention:

- Ensure a smoke alarm is fitted within the room/lobby (and landing where appropriate) opening onto the escape route.
- Avoid Calor gas, paraffin or electric bar fires wherever possible. Instead use plug-in radiators with safety electric plugs.
- Do not block access points in your flat or the communal areas of your block.
- Do not use rooms for storage or as workshops.
- Do not smoke in the communal areas or escape routes.
- Do not overload electrical sockets, do not cover heating appliances or leave lit candles or heaters close to curtains or furniture.
- Ensure electrical equipment is regularly inspected & serviced.
- Common ignition sources which should not be used include; naked flames, sparks, portable heaters, smoking materials, paper, combustible fabrics, plastics, paints, thinners, chemicals, flammable gases.

The following is some valuable Do's and Don'ts relating to Fire Safety measures in your block and within your home.

ESCAPE ROUTES...

- DO familiarise yourself with the escape routes from your home & the communal areas (including any alternative escape routes).

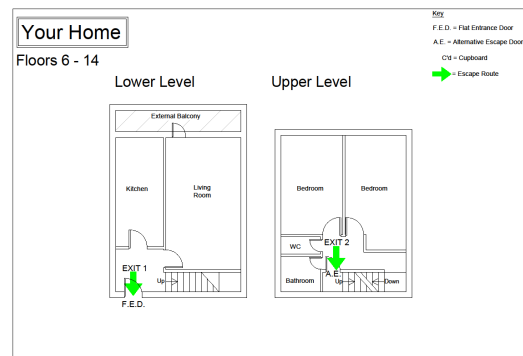
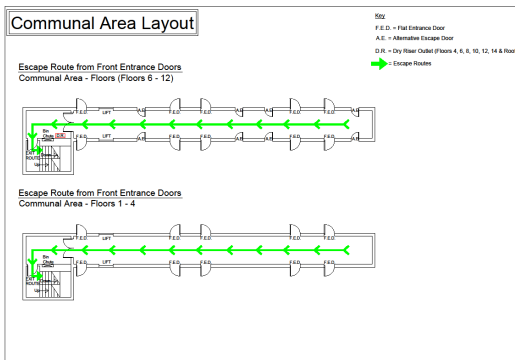

- **DO NOT block the escape routes. These must be kept clear at all times**



X



X



✓

- **DO NOT wedge/prop open any fire doors**



X



X



✓

IN THE EVENT OF A FIRE...



DO raise the alarm by shouting 'FIRE' and leave the building.

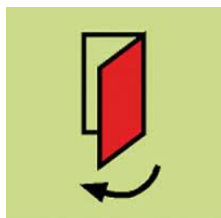

DO close the fire doors including your flat if you evacuate.



DO NOT use the lifts if you are aware of a fire.



DO use the stairs to leave the building.

**GET OUT
STAY OUT
AND CALL
999**

DO call 999 but only when you are safely out of the building.



DO NOT smoke in the common areas of the building or the escape routes.

Some of this information has been produced by the London Fire Brigade. For further information on Fire Safety, please refer to their website. (www.london-fire.gov.uk/FireSafety.asp)

RESIDENTS FIRE SAFETY INFORMATION PACK

Section 5 - Contacts

If you have any queries or concerns relating to Fire Safety help is available from a number of sources. Equally, if you see something within your block that you feel compromises your safety please let us know.

London Borough of Southwark

Fire Safety Team Tele: 0207 525 7565 Email: FRA@southwark.gov.uk.

London Fire Brigade Tele: 0208 555 1200 Email: info@london-fire.gov.uk

For further information on the London Fire Brigade and General Fire Safety, please refer to the London Fire Brigade's website. (<http://www.london-fire.gov.uk/FireSafety.asp>)

If you would like to request and review the Fire Risk Assessment for your block, please refer to the following website:

(http://www.southwark.gov.uk/downloads/download/2403/register_of_fire_risk_assessments)