

DRAFT

**HOUSEHOLDER
DEVELOPMENT**

**SUPPLEMENTARY
PLANNING DOCUMENT (SPD)**

FOREWORD

Over recent years, we have focused in on how to make the planning system more accessible for our residents. The creation of the planning register has made it much easier to search for applications and find associated documents, whilst our digital tools now mean it is much easier to find the policies that apply in each particular circumstance.

With this Householder SPD, we have brought together all of the policies and guidance that might apply to those seeking amendment or extension of their home, into a format which we hope makes things easier to search and understand. This includes information about our climate & environment policies insofar as they apply to existing dwellings and it is our hope through this guidance to encourage homes of the highest design and environmental standards across Southwark.



Councillor Helen Dennis

Cabinet Member for New Homes and Sustainable Development
Southwark Council

CONTENTS

1	Introduction	5
1.1	Overview	5
1.2	What development does it apply to?	6
1.3	Policy context	7
1.4	Key considerations	9
2	Enhancement and alterations	14
2.1	Introduction	14
2.2	Key considerations	14
2.3	Windows and external doors	16
2.4	Insulation	34
2.5	Air source heat pumps	40
2.6	Solar panels	44
2.7	Cycle and bin storage	48
2.8	Off street parking	48
2.9	External painting	55
2.10	Other development	56
3	Extensions	58
3.1	Introduction	58
3.2	Key considerations	58
3.3	Front extensions	66
3.4	Side extensions	67
3.5	Rear extensions	69
3.6	Roof extensions	74
3.7	Garden rooms and outbuildings	80
3.8	Basement extensions	81
	Glossary	84

CHAPTER 1

INTRODUCTION

1 INTRODUCTION

This section provides an overview of the Householder Supplementary Planning Document (SPD). It sets out how this guidance should be used and who should be using it. It provides a policy overview and sets out the key things to consider when planning works to existing homes in Southwark.

1.1 Overview

The purpose of this supplementary planning document (SPD) is to set out the standard of design expected from the development of existing homes in Southwark.

The SPD has the following objectives:

- To guide the improvement and adaptation of existing homes
- To ensure a high standard of housing for all, ensuring homes are enjoyable, liveable and accessible.
- To encourage the refurbishment of homes looking to reduce energy demand, carbon emissions and adapt to the effects of climate change.
- To ensure works to existing homes mitigate impact on the amenity, privacy and appearance of the surrounding area and neighbours.
- To encourage sustainable technologies, healthy communities and to preserve Southwark's rich heritage.

1.2 What development does it apply to?

The guidance in this SPD is relevant to all existing homes, whether a house or a flat. The SPD also covers homes which are Listed Buildings or within Conservation Areas. It does not apply to the creation of new homes.

The guidance covers a broad range of works you can consider when looking to improve or extend your home. This includes:

- Improving the appearance of your home
- Improving the thermal performance or energy efficiency of your home
- How to find the most appropriate type of extension for your home
- Whether planning permission or Listed Building Consent is required
- If any specialist information is required to support your planning application

Summary tables have been included at the start of each section to help you quickly see if you need planning permission or Listed Building Consent. Detailed guidance is then provided where relevant.

Is permission required for insulation?

Houses	Flats/Maisonettes	Conservation Area	Listed Buildings
A planning application is not required unless the external appearance of a building is changed.	A planning application is not required unless the external appearance of a building is changed.	A planning application is required for external but not internal insulation.	Listed Building Consent and a planning application are required.

Table 1: Example of a summary table

You must seek your own independent advice before proceeding with any development proposals to ensure it complies with all relevant legal requirements.

1.3 Policy context

This SPD provides guidance for applying the policies in the Southwark Plan 2022. It does not contain new policy. The SPD will be a material consideration in the determination of a planning application.

The Southwark Plan 2022 is the development plan for Southwark. It is in conformity with the broader guidelines and policies set out in the London Plan 2021 and the National Planning Policy Framework (NPPF) 2023.

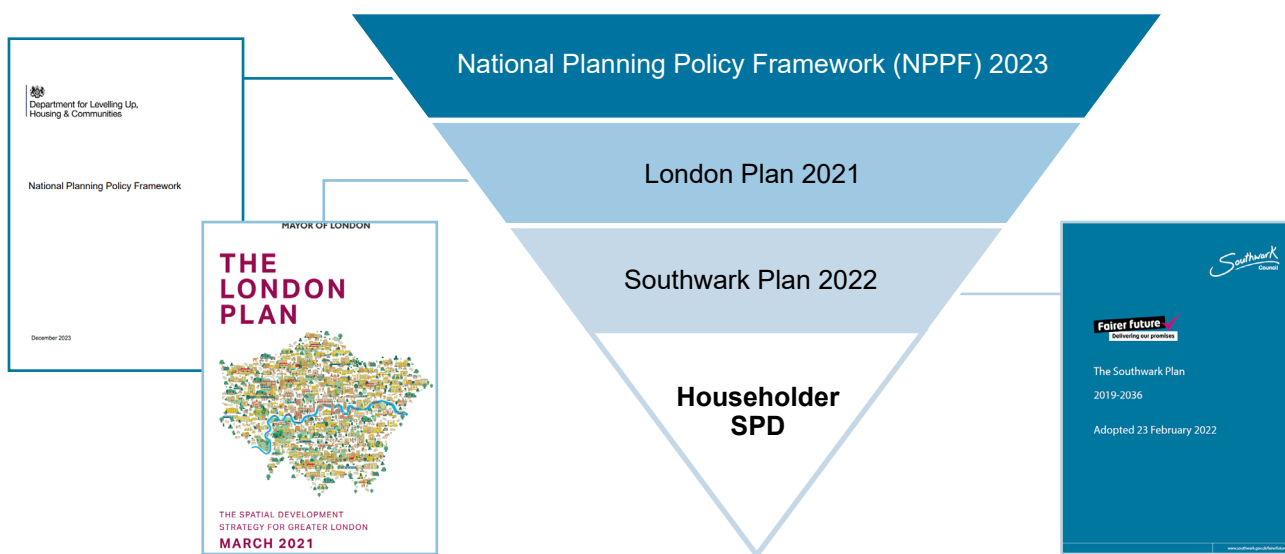

Figure 1: Policy context

1.3.1 National policy

Permitted development

You can carry out certain improvements and extensions without submitting a planning application. This is where planning permission for certain works is already granted by national legislation. This is known as permitted development. These regulations are set out in the General Permitted Development Order 2015 (GDPO).

For example, you may be able to add a large single storey extension to your home under permitted development. This is subject to limitations by the GDPO and only applicable to homes outside of Conservation Areas. You will also need to apply for 'Prior Approval' for these large rear extensions. The council will consult adjacent neighbours to ensure that their amenity would not be harmed by the proposals.

Permitted development does not apply to flats or maisonettes. If you live in a flat (including a house converted into flats) or a maisonette, then you will need to apply for planning permission for external changes.

Permitted development is restricted in Conservation Areas and other areas where the council has issued an Article 4 Direction. These are used to control small-scale changes which may erode the character of an area over time. This could be through the loss or alteration of windows, doors, roofs or front gardens. More information about Article 4 Directions can be found [here](#). You can also check if there are any Article 4 Directions on your property using [Southwark Maps](#).

1.3.2 Local policy

Southwark Plan 2022

The Southwark Plan 2022 contains multiple relevant policies, for which this SPD provides further guidance:

- Policy P13 (design of places) sets out numerous design principles including that development must “ensure height, scale, massing and arrangement respond positively to the existing townscape, character and context; and better reveal local distinctiveness and architectural character; and conserve and enhance the significance of the local historic environment”.
- Policy P14 (Design Quality) establishes further principles relating to daylight and sunlight, outlook, response to context, sustainable design, inclusive design, and basements.
- Policy P15 (Residential Design) states that “development must achieve an exemplary standard of residential design”.
- Policy P56 (Protection of Amenity) states that “development should not be permitted when it causes an unacceptable loss of amenity to present or future occupiers or users”.
- Policy P69 (Sustainability Standards) states that “development must: reduce the risk of overheating, taking into account climate change predictions over the lifetime of the in accordance with prioritised measures set out in the following cooling hierarchy.”
- Policy P70 (Energy) states that ‘Development must minimise carbon emissions on site in accordance with the following energy hierarchy: 1. Be lean (energy efficient design and construction); then 2. Be clean (low carbon energy supply); then 3. Be green (on site renewable energy generation and storage).’

In addition, other policies relating to conservation and heritage, environmental protection, designing out crime, and archaeology may be of relevance.

1.4 Key considerations

There are many factors which you need to consider before planning works to your home. These are detailed in the relevant sections of the SPD as well as summarised below.

1.4.1 Improving energy and thermal performance

Improving the energy and thermal performance of a home is a key objective for many residents. It aligns with the Southwark Climate Change Strategy which sets out the steps the borough needs to take to be carbon neutral by 2030.

Improving energy and thermal performance can also help to reduce carbon emissions and make your home more resilient to the effects of a changing climate.

Free pre-application advice service

The council offers a free planning advice service for the following works:

- Solar panels
- Heat pump
- External insulation

This is so we can support our residents' transition to low and zero carbon solutions for heating, powering and insulating their homes. This can contribute to reducing energy demand and energy bills.

This service is available to all homeowners, including owners of flats. You can use this service to discuss the proposed works with a planning officer. This can help to resolve any design issues before submitting a planning application.

Reducing carbon emissions

It is important to consider how you can reduce your carbon emissions when planning works for your home. The energy hierarchy on the next page sets out an order of priority for considering carbon reductions. This is underpinned by Southwark Plan (2022) Policy P70 (Energy).

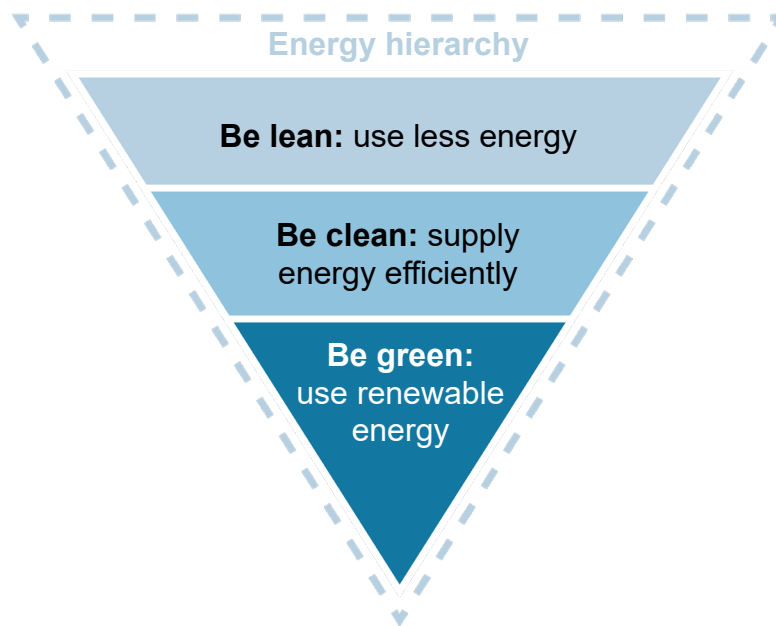

Figure 2: Energy hierarchy

'Be lean' savings should be prioritised and made by using energy efficient design and construction. This encourages a consideration of carbon reduction at the start of a design process. The lifespan of materials used in the works should be considered as well as the potential for natural cooling or heating. This may also include the use of draught proofing or insulation to improve the thermal performance of your home.

The 'be clean' stage encourages the use of a low carbon energy supply such as a heat pump. The 'be green' stage encourages the use of on-site energy production, such as solar panels.

As best practice, the use of low carbon, recycled and re-used materials, as well as recycling any materials removed from the site is encouraged.

Whole Building Approach

We encourage a '[Whole Building Approach](#)' when planning works to your home. This involves considering your whole home when trying to improve energy and thermal performance.

A home performs best when many (or all) parts are functioning, rather than one element. You should consider how different factors such as ventilation, heating and insulation interrelate. This can help to regulate the temperature in your home and make it more resilient to the effects of a changing climate.

The phasing of works needs to be planned to avoid creating other issues such as damp or poor ventilation. This involves the timing of which building element to refurbish – when, how and in which order. You should also check your home for draughts. For example, the use of insulation will not be as effective if your home is draughty.

A Whole Building Approach should further consider the lifespan of each building element. This should include whether the feature can be repaired, reused or recycled in future. You should also consider the frequency that this must be undertaken. This will help to reduce whole life cycle emissions.

1.4.2 Heritage assets

Additional consideration will need to be given if your home is listed or within a Conservation Area. You can check if your property is listed or within a Conservation Area by using Southwark Maps. Further information can also be found on heritage assets in the Heritage SPD (2021).

Listed Buildings

If your home is listed, Listed Building Consent will be required for most works covered in this SPD. This is often in addition to planning permission but there are works where only Listed Building Consent is required. This has been set out in the relevant sections of this SPD.

You will have to consider the impact your planned works will have on the special interest of your listed home. This is underpinned by the Planning (Listed Buildings and Conservation Areas) Act 1990. Special care needs to be taken to ensure any original or historic fabric is retained in any works. This refers to any original or historic features such as windows or doors as well as walls within your home. Special care also needs to be taken to ensure any planned works do not detract from the external appearance of your home. This is generally of great importance to the character, significance and historic interest of the Listed Building.

You will also need to check whether your home is listed as part of a group of buildings. If so, you will need to consider the impact any works would have on the significance of the wider listed group. Group listing commonly applies to terraced properties. The whole terrace is usually included in the listing as opposed to one individual home. If your home is group listed, you will need to ensure any works maintain consistency across the group and do not introduce features which will detract from the Listed Buildings. You can find out whether your home is group listed in the Listed Building description. The description will refer to your property's address on its own or part of a wider group.

Guidance is provided within each relevant section on how to ensure planned works are appropriate for Listed Buildings. Some works may not be acceptable at all within a Listed Building. Alternative solutions are proposed in these cases.

Conservation Areas

If you live in a Conservation Area, you will need to consider the impact any planned works would have on the wider area.

Works need to be sympathetic to the individual character of the Conservation Area. There may be a dominant style of window or defining feature which is important to the area's character. This character is required to be preserved or enhanced by any proposed works. This is underpinned by the Planning (Listed Buildings and Conservation Areas) Act 1990.

Each Conservation Area has its own Conservation Area [Appraisal](#). The appraisals outline the special importance of the area and its defining character. The appraisals also set out guidance on the type of development allowed in the area. This includes the most common materials and which materials are considered inappropriate.

It is recommended you read the appraisal for your area before planning works. Guidance can change between Conservation Areas as it reflects each area's own character.

1.4.3 Trees

Trees are very important to the borough and the council has a duty to protect them under the Town and Country Planning Act 1990. This can be done by placing a Tree Preservation Order (TPO) on the trees.

Trees improve the amenity of an area and have other environmental benefits. The benefits of trees include to:

- Provide landscaping
- Provide shading
- Provide habitats for biodiversity
- Improve air quality
- Reduce the urban heat island effect
- Reduce surface water flood risk

Trees are also important for carbon storage (especially mature trees) and enhance the borough's climate resilience.

You will need to apply to work on protected trees if your proposal could affect trees protected by a TPO or trees in Conservation Areas. You can check if a tree on your property is protected by a TPO or in a Conservation Area by using [Southwark Maps](#).

CHAPTER 2

ENHANCEMENTS AND ALTERATIONS

2 ENHANCEMENT AND ALTERATIONS

2.1 Introduction

This chapter sets out the enhancements and alterations a resident can consider when looking to improve their home. This refers to works which seek to improve the appearance, energy efficiency or thermal performance of your home. There is further guidance on other additions that can be made to your home such as cycle or bin storage.

This chapter also provides guidance on any relevant planning considerations. These could include design quality, impact on neighbours, and impact on heritage assets (such as Listed Buildings and Conservation Areas).

Some enhancements and alterations are [permitted development](#) subject to conditions and limitations. This guidance should be read alongside the Permitted Development (Town and Country Planning (General Permitted Development) (England) Order 2015 (as amended).

2.2 Key considerations

There may be many factors which need to be considered before planning works to your home. This will depend on the type of property you live in and where it is located.

2.2.1 Whole Building Approach

We encourage a 'Whole Building Approach' when planning works to your home. This involves considering your whole home when trying to improve energy and thermal performance.

A home performs best when many (or all) parts are functioning, rather than one element. Piecemeal improvements can result in suboptimal performance and unforeseen issues. This could include increased condensation or mould growth. Certain additions will not be as effective if an existing feature is not working. For examples, heat pumps will not function as well as expected if your windows are draughty.

Figure 3 on the next page demonstrates a Whole Building Approach to improving your home. The approach shows which parts of your home to consider first. This ranges from small fixes such as draught and damp proofing to larger interventions. Often the small fixes can be a simple and cost-effective way to improve the thermal performance and energy efficiency of your home. This can also help make your home more resilient to the effects of a changing climate.

The guidance in this chapter is structured to follow this Whole Building Approach.

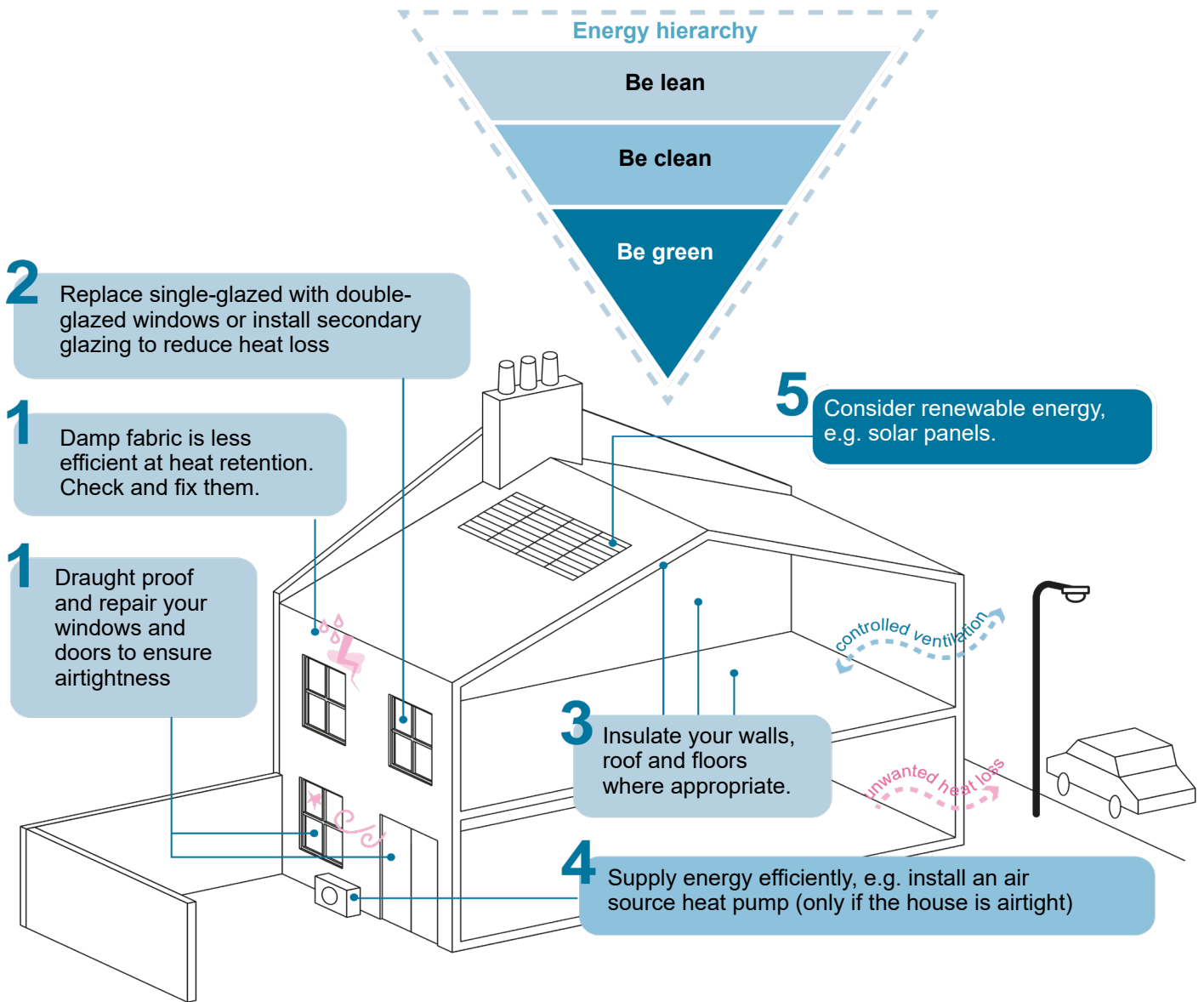

Figure 3: Illustrative diagram of the Whole Building Approach

2.2.2 Heritage assets

Special care needs to be taken when planning improvement works if your home is listed or within a Conservation Area.

The work should not harm the character of your home, or the area and care should be taken to avoid adverse impact on historic features. The works could also risk the long-term deterioration of the building or features.

The aim should be to improve the performance of your home as far as practical. Often, the least disruptive intervention should be sought. For example, insulation could be better placed internally rather than externally. This is because the external appearance of a listed home or Conservation Area is very important. Placing insulation externally may disrupt its character or impact a historic feature such as a brick wall.

Further guidance on energy performance standards in historic buildings is available from Historic England.

2.3 Windows and external doors

Windows and external doors help to keep your home light and secure and are important for ventilation. They also contribute positively to the composition and appearance of your home and help to give a consistent appearance to the surrounding area.

Windows and external doors can generally be the least insulated features of homes, especially as glass within windows transmits the heat and cold easily. Repairing or draught proofing may improve the thermal performance of your windows and external doors without the need for replacements. Repairs can also fix cosmetic issues.

Windows and doors do however have a lifespan and sometimes they will need to be replaced. You may also wish to install new windows or external doors where they have not existed previously.

2.3.1 Draught proofing

Is permission required for draught proofing?

Houses	Flats/Maisonettes	Conservation Area	Listed Buildings
Planning permission is not required.	Planning permission is not required.	Planning permission is not required.	Neither planning permission or Listed Building Consent is required.

Table 2: 'Is permission required for draught proofing?'

Draughts in windows and doors are unwanted gaps which let cold air in and warm air out. Draught-proofing your windows and external doors is a cost-effective intervention to reduce heat loss and keep your home warm. It is also the least intrusive method of improving thermal performance.

Draught proofing can help to regulate the internal temperature during extreme weather events such as heatwaves or cold snaps. This can help make your home more resilient to the effects of a changing climate.

Once implemented, it is likely that less energy will be required for heating your home. Draught proofing can also reduce the amount of dirt and dust entering your home.

It is important to have the right amount of ventilation when considering draught proofing to prevent damp and condensation building up.

You do not need planning permission or Listed Building Consent to draught proof your windows or external doors.

Figure 4 on the next page demonstrates how to find and fix gaps within your home.

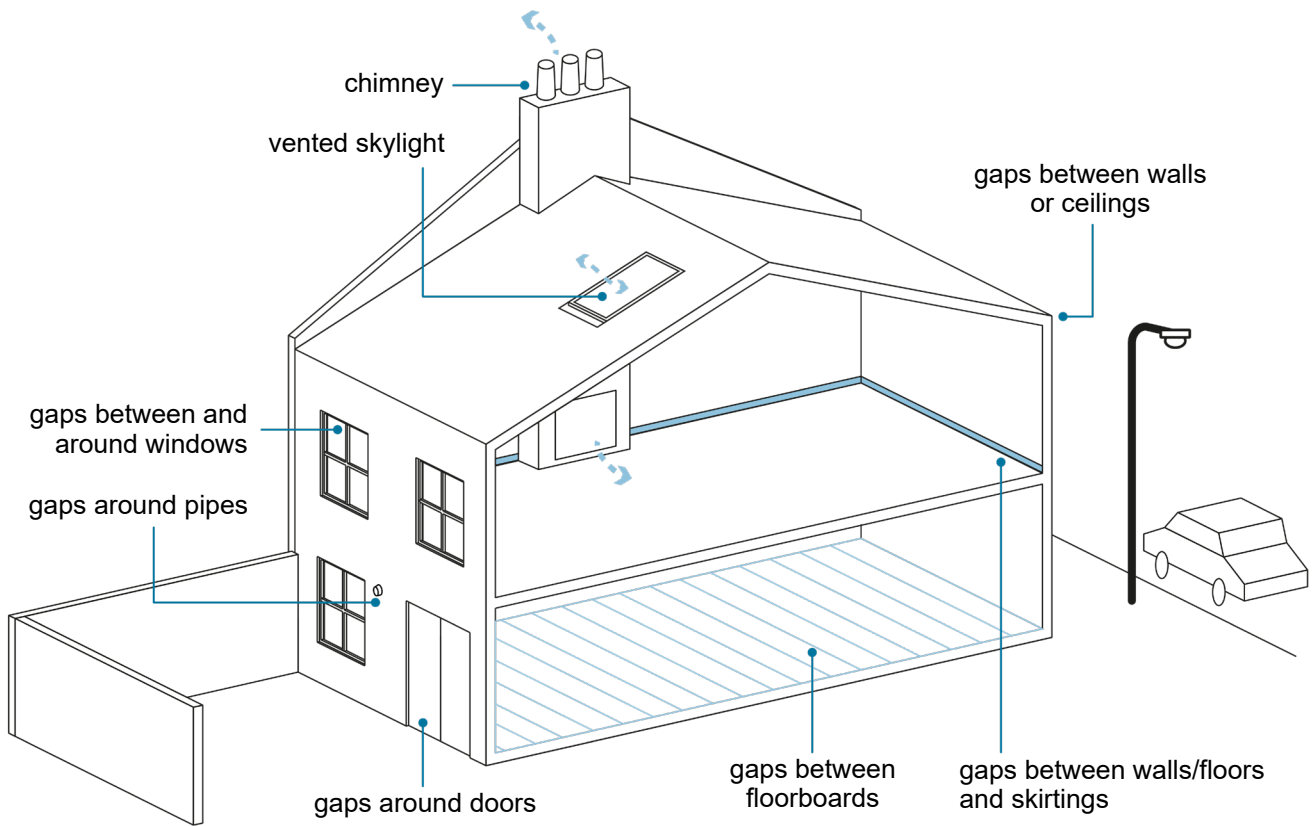

Figure 4: Find and fix gaps

2.3.2 Repair of windows and external doors

Is permission required for repairing existing windows or external doors?

Houses	Flats/Maisonettes	Conservation Area	Listed Buildings
Planning permission is not required.	Planning permission is not required.	Planning permission is not required.	Neither planning permission or Listed Building Consent is required.

Table 3: 'Is permission required for repairing existing windows or external doors?'

Before deciding to replace windows and doors, the option to repair should be considered.

The full replacement of windows and doors may not always be necessary. For example, if there is damage or rot to only one section of a window or door, it may be more cost-effective to repair instead of replacing.

Repair is preferable to replacement for the following reasons:

- Repair is often cheaper.
- Seasoned timber used in older windows or doors is often of higher quality and durability than modern timber.
- Original windows and doors in older buildings can give your home character and improve the appearance overall.
- Repair is more sustainable and reduces carbon emissions associated with manufacturing new replacements.

Examples of repairs to existing windows and doors include:

- Work to maintain and repair the foot of doors and the base of frames where they have suffered rot or other damage.
- Replacing plain panes of glass, where broken, to match the existing.
- Repainting the frames.
- Repairing the seal on double-glazing

You do not need planning permission or Listed Building Consent to repair existing windows or external doors. Further guidance on repairs within Listed Buildings can be found on Historic England's [website](#).

If your windows and doors are beyond repair and require full replacements, please refer to [section 2.3.5](#) for guidance.

2.3.3 Double glazing

You may wish to replace your windows with double-glazed units to improve the thermal performance of your home. Double glazing is a window which has two panes of glass, separated by a sealed gap which reduces heat transfer. Double glazing can provide better insulation for your home as it can prevent cold air entering a room whilst also retaining heat. This can help regulate internal temperatures during extreme weather events (such as heatwaves or cold snaps) and make your home more resilient to the effects of a changing climate.

Other benefits of double glazing include:

- Reduced condensation and mould (from airtight seals)
- Noise reduction (from thicker panes and the air gap in between)
- Heightened security (from thicker panes being harder to break)

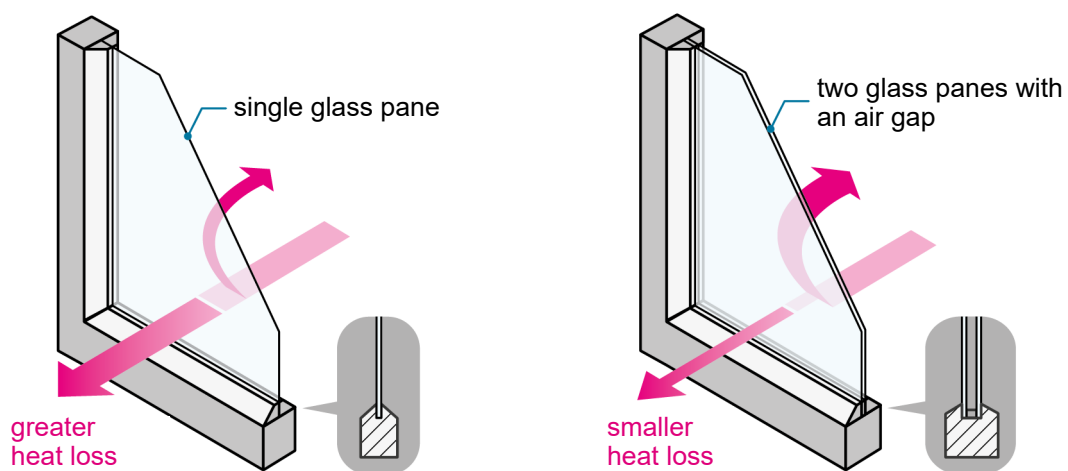

Figure 5: Single glazing compared with double glazing

We encourage the use of double glazing within most homes in the borough, given the many benefits. Double glazing is permitted within Conservation Areas; however, the windows need to reflect the character of the area and be of a traditional or sympathetic design and material.

Guidance on how best to replace your windows and whether planning permission is required is detailed in [section 2.3.5](#).

Listed Buildings

Double glazing is not permitted in Listed Buildings, including slim versions. It may be replaced if double glazing has been permitted in the past or part of the original build.

This is in line with Historic England’s guidance which encourages the retention and repair of historic features such as windows.

The use of double glazing is considered harmful to Listed Buildings. It often involves the removal of historic and original windows and introduces modern features which are not authentic or compatible. Most Listed Buildings in the borough are historic, dating from the Victorian or Georgian period. By contrast, double glazing is an inherently modern feature which is not usually seen as sympathetic or in keeping with the age and character of our Listed Buildings.

It can often be three times the thickness of the existing single glazed windows. This would disrupt the historic detailing of a Listed Building and alter its appearance and overall character. Many of the listed homes within the borough are also in groups or terraces where single glazing is retained across all the buildings. The introduction of double glazing here can disrupt the uniformity of these listed terraces or groups

We are aware of the need to improve the thermal performance of listed homes, and to address climate emergency and the Southwark Climate Change Strategy. However, Listed Buildings only account for around 2% of all buildings in Southwark. Once lost, historic or original windows are irreplaceable.

There are also other ways to improve the thermal efficiency of Listed Buildings. This could involve secondary glazing (sections 2.3.4) or internal insulation (section 2.4.1-2.4.2). Existing windows within Listed Buildings can also be draught proofed (section 2.3.1) or repaired (section 2.3.2).

2.3.4 Secondary glazing

Is permission required for installing secondary glazing?

Houses	Flats/Maisonettes	Conservation Area	Listed Buildings
Planning permission is not required.	Planning permission is not required.	Planning permission is not required.	Listed Building Consent is required, but not planning permission.

Table 4: ‘Is permission required for installing secondary glazing?’

Secondary glazing is different to double glazing in that the existing window remains unaltered. It involves the installation of a separate internal window on the inside of the existing window. This replicates the airtight seal and insulation gap offered by double glazing. Secondary glazing can offer the same benefits of double glazing. This includes increased insulation and noise reduction.

Secondary glazing can be installed to replicate the existing arrangement of the window. It can also be fixed shut or installed with a horizontal or vertical opening. Keeping the secondary glazing openable allows access to the existing window so it can still be opened, cleaned and maintained. Secondary glazing can also be designed to be removable in warmer months when extra insulation is not needed.

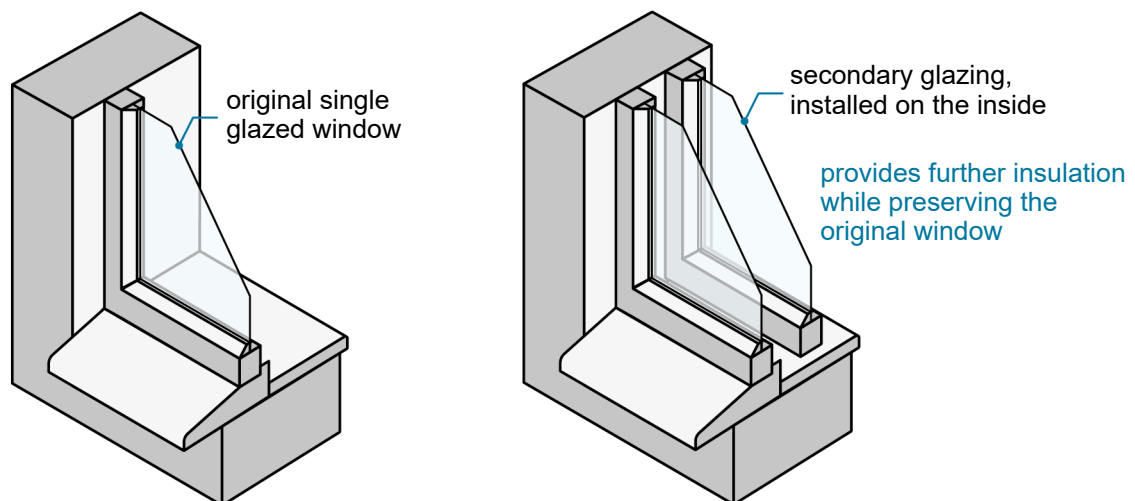

Figure 6: Secondary glazing

The use of secondary glazing is a useful approach within Listed Buildings, where double glazing is not permitted. Secondary glazing provides similar benefits of double glazing without having to replace historic or original windows. This better preserves the character of your home.

You do not need planning permission for the installation of secondary glazing. Listed Building Consent will however be required if your home is listed.

2.3.5 New or replacement windows or external doors

Is permission required for new or replacement windows or external doors?

Houses	Flats/Maisonettes	Conservation Area	Listed Buildings
<p>Planning permission is generally not required unless the proposal falls within the list of exceptions of permitted development.</p>	<p>Planning permission is generally not required if the windows or external doors are like-for-like replacements.</p> <p>External doors refer to the door which accesses the street or outside area.</p> <p>New windows or external doors will require planning permission.</p>	<p>Planning permission is generally not required if the windows or doors are like-for-like replacements.</p> <p>Planning permission is not generally required for new windows or external doors, unless an Article 4 Direction is in force.</p>	<p>Listed Building Consent will be required as well as planning permission in some circumstances.</p>

Table 5: 'Is permission required for new or replacement windows or external doors?'

Refer to [section 3.6](#) in Chapter 3 for guidance on new or replacement dormer windows.

Houses

You do not generally need planning permission for new or replacement windows or external doors within houses as the works are [permitted development](#). Different requirements and restrictions apply if your home is listed or within a Conservation Area. You will also need to apply for Listed Building for works to a listed home. This guidance is provided in the next sections.

Planning permission is not required if the new or replacement windows or external doors are similar in appearance to the existing at your home. Planning permission will be required if the appearance of your home will be noticeably changed.

A similar in appearance window or external door should keep the dimensions and overall arrangement of the existing. The material, colour and glazing type may change. [Fact box 1](#) provides further examples of similar in appearance windows and doors.

Planning permission will also be required if any of the following applies:

- The new window(s) is for an upper floor on the side of your house (including the roof slope) and would be clear-glazed. Windows which are obscured-glazed in this position do not need planning permission.
- The new window(s) is for an upper floor on the side of your house (including the roof slope) and is openable at a level less than 1.7m above the floor of the room in which it is installed.
- Permitted development rights have been removed by an Article 4 Direction or a condition attached to an earlier planning permission restricting the use of windows or doors.

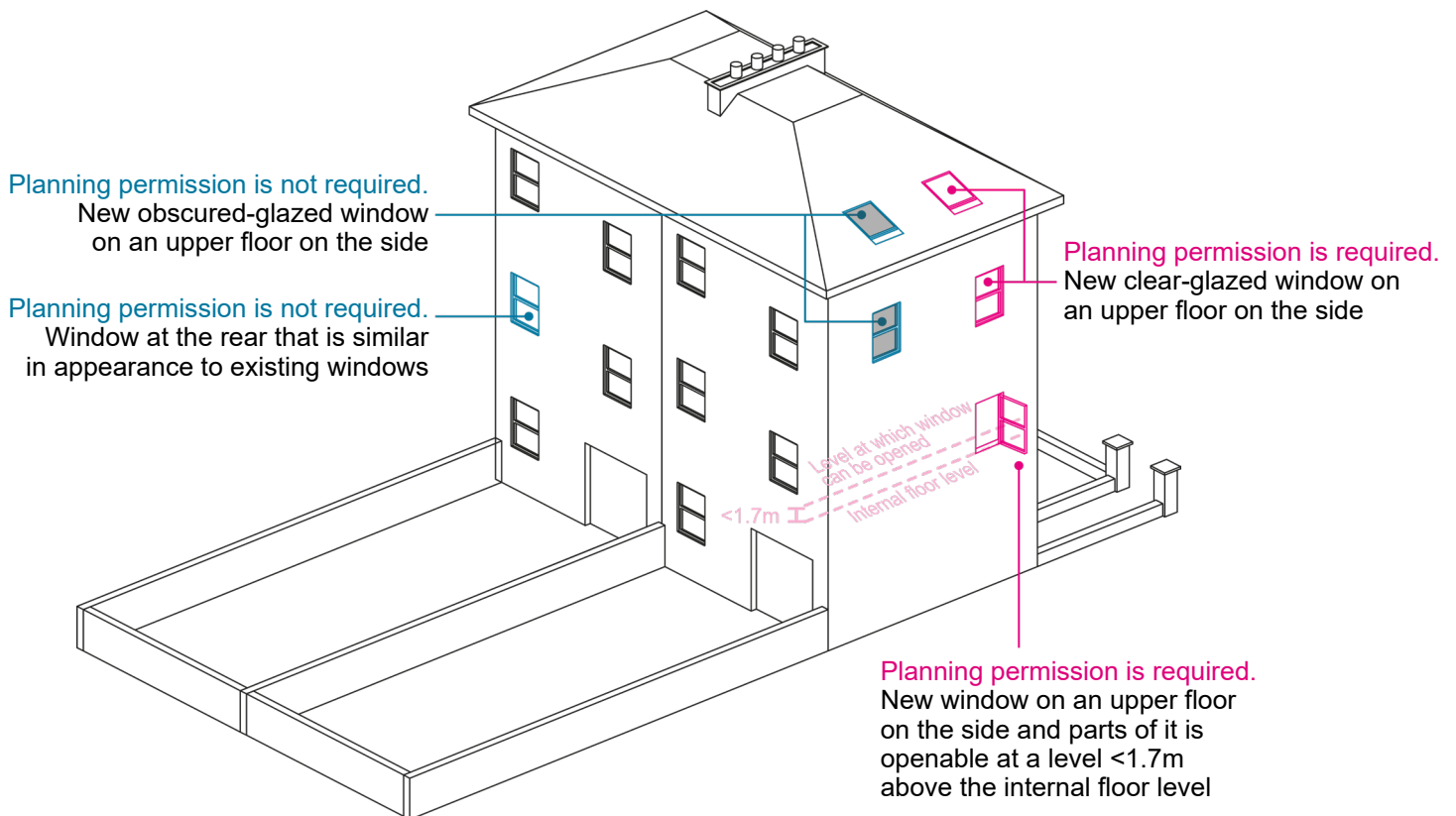

Figure 7: Permitted development right for new or replacement windows

Flats and maisonettes

i

External doors refer to the door which accesses the street or the outside area of your building.

Planning permission is not required for like-for-like replacement windows or external door(s). The replacements would have to be the same material, size and design to be like-for-like. The glazing type can be changed. This means you can change from single to double glazing and still be considered like-for-like. **Fact box 1** provides further examples of what is a like-for-like replacement.

Planning permission will be required for new windows or external doors or for replacements which are not like-for-like.

Different requirements and restrictions apply if your home is listed or within a Conservation Area. You will also need to apply for Listed Building for works to a listed home. This guidance is provided in the next sections.

Care should be taken to ensure any new or replacement windows or doors are sympathetic to the existing windows at the property. This is to ensure consistency across all the flats or maisonettes within a block.

If you are a leaseholder, you may also need to gain permission from the freeholder of the site before being able to carry out the works. The freeholder may also have their own requirements and restrictions on works.

Conservation Areas

Planning permission is not required if the replacement windows or external doors are like-for-like. The replacements would have to be the same material, size and design to be like-for-like. The glazing type can be changed. This means you can change from single to double glazing and still be considered like-for-like. **Fact box 1** provides further examples of what is a like-for-like replacement.

Planning permission will be required for new windows or external doors or for replacements which are not like-for-like.

Original or historic windows or doors should be repaired where possible. This can often be cheaper than replacement, given the high quality and durability of older timber. More guidance on repairing windows and doors is provided in **section 2.3.2**.

Where replacements are required or new windows or doors are to be added, the historic importance and character of the Conservation Area should be considered. The windows or doors would need to be in a style and material which is sympathetic to the area and maintain or improves its overall appearance. Detailed assessments of the importance and character of each Conservation Area can be found within the area appraisals.

Generally, we require the use of traditional materials such as timber within Conservation Areas. Traditional materials tend to last longer than modern substitutes, giving better value and being more sustainable over time. Metal windows or doors will be permitted in certain areas. However, this is generally only to the rear or non-public facing elevations. Windows and doors should also be painted in traditional colours. Windows are generally expected to be off-white. However, doors can be painted in a broader range of heritage colours such as navy, maroon, dark green or black. Garish colours will not be permitted.

i

Guidance can change between Conservation Areas, and it is recommended you read the appraisal for your area before planning works as this will state which materials and colours are acceptable.

UPVC (Unplasticized Polyvinyl Chloride) will not be permitted in any of our Conservation Areas, even to the rear of a property. UPVC generally appears out of place in Conservation Areas, owing to the plastic appearance. UPVC also may weather or behave differently from natural and more traditional materials. The replacement of UPVC windows or doors with more sympathetic, traditional materials is encouraged.

New or replacement windows or doors must maintain the quality of design at your home. Features such as the depth of reveal should be retained (see [Figure 8](#)). Doors should be of traditional design, generally panelled or boarded. These should be a painted timber rather than stained hardwood. Modern designs such as metal framed, or sliding may be acceptable in places.

There should also be a continuation of the established hierarchy of windows at your home. Generally, windows are larger or more ornate at the lower levels of a house, reducing in size and decoration on the upper levels (see [Figure 9](#)). This should be respected with any new or replacement window. Overly large windows will not be permitted at the upper levels of properties, even to the rear.

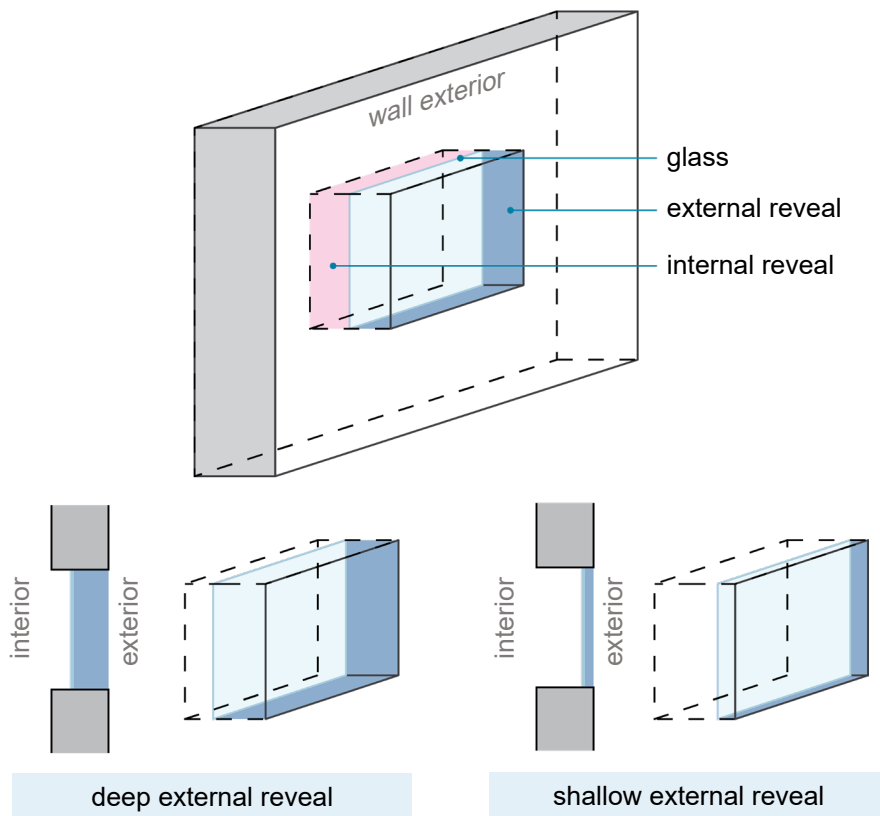

Figure 8: Depth of reveal

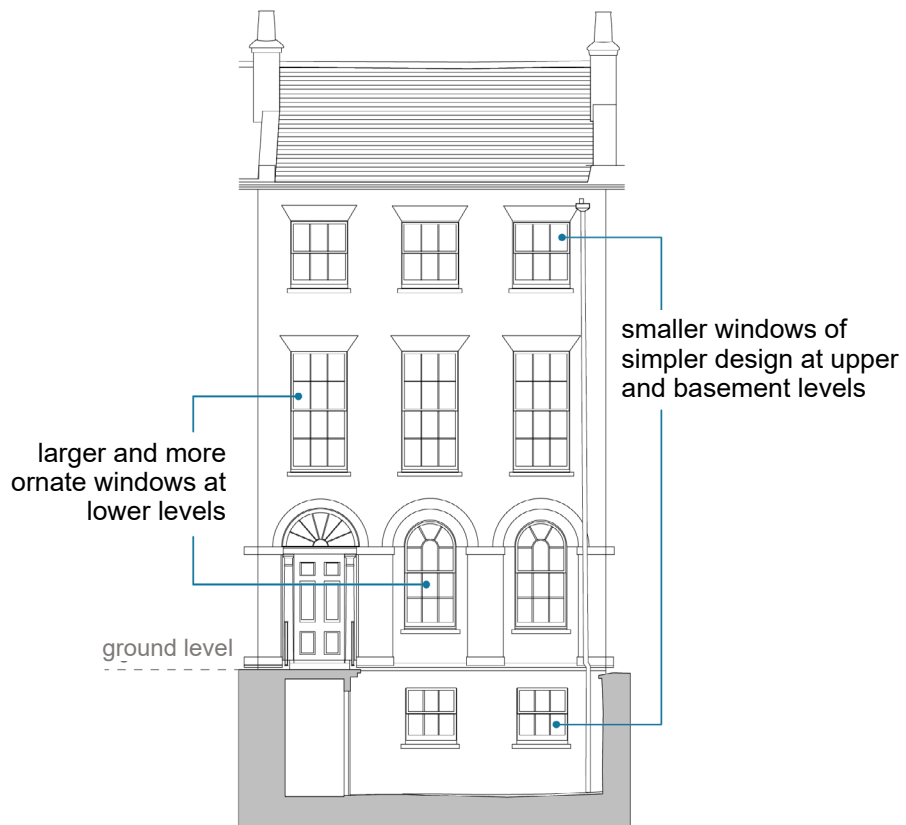

Figure 9: Typical window fenestration

Listed Buildings

Listed Building Consent is required for any new or replacement windows or doors within Listed Buildings. This applies to both internal and external doors at your home.

Replacement windows or doors

Replacement windows or doors would need to be like-for-like with the existing at your home. The replacements would have to be near replicas of the existing windows and doors. The glazing type would also have to remain the same. Double glazing is not permitted in Listed Buildings. It may be replaced if double glazing has been permitted in the past or part of the original build. **Fact box 1** provides further examples of what is a like-for-like replacement.

The replacement of windows or doors within Listed Buildings will not be permitted unless it can be demonstrated that the existing versions are beyond their lifespan, and it is not economically viable to pursue repairs. Modern windows or doors of unsympathetic design and materials can be replaced with an appropriate alternative.

Original or historic windows or doors should be repaired where possible. This is often a cheaper cost than replacement, given the high quality and durability of older timber. Repairing windows or doors in Listed Buildings can also better insulate your home. For example, a full repair of a sash window could include the restoration of its frame, a rehanging of the internal counterweights and the installation of draught seals. Such repairs can reduce draughts and improve the thermal performance of your home. It also ensures original or historic features are preserved. More guidance on repairing windows and doors is provided in section 2.3.2.

You will need to include a condition survey as part of a Listed Building Consent application to replace your windows or doors. It is required to justify replacement instead of repair. It should include a breakdown of the status and photographs of each individual window or door proposed to be replaced.

Creation of new windows or doors

You may be able to create new window or door openings in your home, provided it does not cause harm to the significance of the Listed Building.

The installation of a new window or door will generally involve the removal of a section of wall to create a new opening. Consideration must be given to the location of any new window or door and the impact this will have on the significance of the Listed Building.

Any new window should continue the established hierarchy of windows at your home and be in keeping with the style and design of existing windows. Overly large windows or doors or those in an unsympathetic material or design will not be permitted, even to the rear. Exceptions may be made when new doors or windows are proposed as part of new extensions.

General considerations

UPVC (Unplasticized Polyvinyl Chloride) will not be permitted in Listed Buildings, even to the rear of a property. UPVC cannot match the sections and proportions of historic joinery and cannot replicate the appearance of traditional materials. If UPVC windows or doors have been installed in the past, their replacement with more traditional materials is encouraged.

New or replacement windows or doors must maintain the same design quality as the existing versions. Features such as the depth of reveal, sympathetic materials and glazing pattern should therefore be retained (see [Figure 8](#)).

You will also need to check whether your home is listed as part of a group of buildings. If so, you will need to consider the impact any works would have on the significance of the wider listed group. You can find out whether your home is group listed in the Listed Building description. The description will refer to your property's address on its own or part of a wider group.

i

Fact box 1: What is considered 'similar in appearance' and 'like-for-like'?

A new or replacement window or door is considered 'similar in appearance' if it follows the arrangement and dimensions of the existing. The glazing bar pattern, material, colour and glazing type may be changed.

A 'like-for-like' replacement is a window or door which matches the arrangement, glazing bar pattern, dimensions, material, and in some cases, colour of the existing. The glazing type does not need to be retained unless it is for a Listed Building. A like-for-like replacement is important to ensure any new window or door retains the character and appearance of a home.

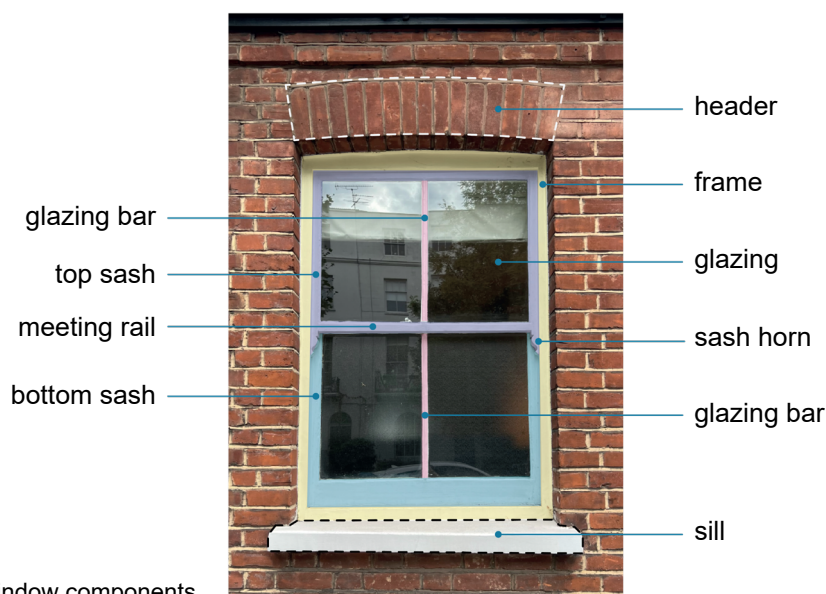

Figure 10: Window components

Arrangement

Arrangement refers to the glazing bar pattern or style of glass panes in a window or door.



Similar in appearance	Like-for-like
<p>To be considered 'similar in appearance' the overall arrangement and style must be retained. For example, a large single pane casement window can be split into two and still be considered 'similar in appearance'. However, if you wanted to replace a rectangular casement window with a circular window then it would not be considered similar in appearance.</p> <p>The arrangement should also broadly match the other existing windows or doors at the property. For example, if you are replacing one window at the front of your property then the replacement would be expected to be consistent with the other windows at this elevation.</p>	<p>To be considered 'like-for-like' the overall arrangement would have to replicate the existing window or doors at your home.</p>

Material

Similar in appearance	Like-for-like
<p>The material of a replacement window or door does not need to match the existing to be considered 'similar in appearance'.</p> <p>For example, an aluminium door can be used to replace a UVPC door if the overall arrangement and dimensions are retained.</p>	<p>A like-for-like replacement would be expected to be the exact same material as the existing. For example, a timber window or door cannot be replaced with an aluminium or UVPC replacement as this constitutes a change in the material. Even if all other elements of the window or door such as the arrangement or colour are replicated, the material must also be the same as the existing. This also includes windows or doors finished to look like other materials (i.e., a UVPC replacement finished to look like timber).</p> <p>A change in material will be permitted if the new material is an enhancement over the original. For example, a UVPC window or door will be permitted to change to a timber version (especially in a Conservation Area or Listed Building) as this material is of a higher design quality.</p>

Dimensions



Similar in appearance	Like-for-like
<p>A replacement window or door is not considered to be similar in appearance if it increases or decreases the existing opening. Replacement windows and doors should be the same size as the existing.</p> <p>Planning permission will be required if the existing window or door opening is being extended or reduced.</p>	<p>A replacement window or door is not considered to be a like-for-like replacement if it increases or decreases the existing opening. Replacement windows or doors should be the same size as the existing.</p>

Colour

Similar in appearance	Like-for-like
<p>The colour of a replacement window or door does not need to match the existing to be considered 'similar in appearance', however it does need to be in line with the other windows or doors at your property.</p>	<p>If the colour of an existing window or door contributes to the significance of a Listed Building or surrounding Conservation Area, then it should be replicated on any replacement.</p> <p>For example, if most windows within a Listed Building or Conservation Area are off cream then any replacement window should be off cream also. If there is no common colour of windows or doors within a Conservation Area, then any other heritage colours would be considered appropriate.</p>

Glazing type

Similar in appearance	Like-for-like
<p>The glazing type refers to whether a window or door is single or double glazed. The glazing type does not need to be retained to be considered similar in appearance.</p> <p>For example, a single glazed window can be replaced with a double-glazed window if it is considered similar in appearance in all other respects.</p>	<p>The glazing type refers to whether a window or door is single or double glazed. Unless the building is listed, the glazing type does not need to be retained to be considered 'like-for-like'.</p> <p>For example, a house within a Conservation Area could replace a single glazed window with a double-glazed version if it is considered like-for-like in all other respects.</p>

2.4 Insulation

Is permission required for insulation?

Houses	Flats/Maisonettes	Conservation Area	Listed Buildings
Planning permission is not required unless the external appearance of a building is changed.	Planning permission is not required unless the external appearance of a building is changed.	Planning permission is required for external but not internal insulation.	Listed Building Consent and planning permission are required.

Table 6: 'Is permission required for insulation?'

Insulation is one of the best ways to improve the thermal performance of your home. It can protect your home from excessively hot or cold temperatures. This can help to make your home more resilient to the effects of a changing climate. Insulation can also reduce noise pollution.

Insulation is a general term to describe products which reduce heat loss or gain by providing a barrier between areas that are very different in temperature. Common insulation materials used in homes include fiberglass, spray foam, injection foam, cellulose and mineral wool – each with its own pros and cons. More sustainable materials such as hemp are also available. Consideration should be given to the U-value of a product. The lower the value, the better the material as a thermal insulator.

Before any insulation, pre-existing issues with damp or condensation should be addressed. Otherwise, these issues may worsen.

For homes in Conservation Areas or that are listed, care should be taken to provide enough (controlled) ventilation and allow moisture to escape. Insulation materials which are compatible with traditional permeable construction (such as wool) are preferred.

A qualified insulation expert can advise on the best solution for your home. Building Control certification may also be needed for certain types of insulation.

We encourage a 'Whole Building Approach' to insulation. This means that all rooms in your home are considered, not just the ones which are the coldest or warmest. Proposals for insulation will be assessed on a case-by-case basis when a property is listed or located within a Conservation Area. You should consider the least disruptive method possible and provide robust justification for any harm expected to be caused.

2.4.1 Roof and loft insulation

Roof insulation can be carried out internally or externally depending on the roof type or whether the building is listed or within a Conservation Area. Flat roofs should be insulated externally where possible. Such reduces the risk of moisture building up which can lead to structural damage. Internal insulation is best suited to other roof forms such as hip or gabled. It minimises disruption to the roof which could be covered in tiles or shingles.

The two common methods of roof or loft insulation are ‘warm roof’ or ‘cold roof’. Warm roofs fit the insulation to follow the slope of the roof and is best suited to habitable spaces. Cold roofs fit the insulation on top of the ceiling of the room below. It is usually carried out by laying materials between or over the joists. A cold roof insulation is best suited when the loft space is not actively used.

Any roof or loft insulation needs to be carried out by a qualified expert, who can advise on the best solution for your home.

Internal roof insulation - suitable when the roof is tiled.

Warm roof

Insulation is fitted along the slope of the roof. Suitable when the loft space is actively used.

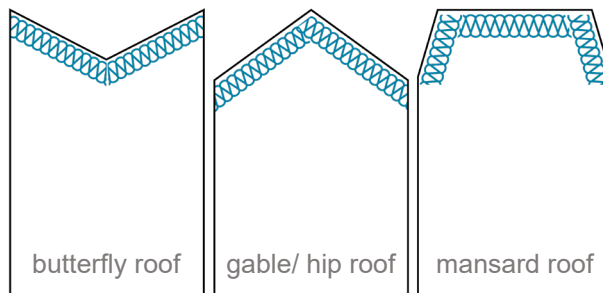

Cold roof

Insulation is fitted on top of the ceiling of the room below. Must be ventilated to avoid condensation and damp.

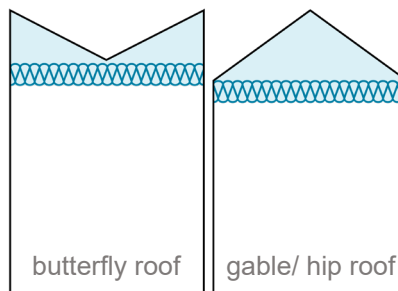

External roof insulation - suitable on flat roofs.

Flat roofs are often covered in modern membranes. External insulation is suitable and less likely to result in condensation.

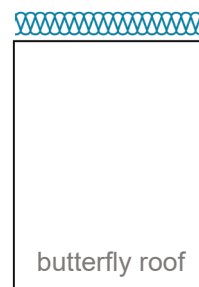

Figure 13: Roof insulation on different roof forms

Houses, flats and maisonettes

Planning permission is not required for internal roof or loft insulation. External roof insulation will not require planning permission unless the appearance of your home is changed. For example, a different finishing material will be applied to the roof, or the roof will increase in size.

Different requirements apply to Listed Buildings and Conservation Areas. They are detailed in the subsequent sections.

If you are a leaseholder, you may also need to gain permission from the freeholder of the site before being able to carry out the works. The freeholder may also have their own requirements and restrictions on works.

Conservation Areas

Planning permission is not required for internal roof or loft insulation within Conservation Areas.

External roof insulation will need planning permission. It is encouraged to use a finish which matches the existing roof materials. The use of inappropriate material such as UPVC will not be permitted.

Listed Buildings

Planning permission and Listed Building Consent will be required for external roof or loft insulation.

Internal roof or loft insulation may be permitted in Listed Buildings if there is no harm to significant roof features such as original rafters or beams. Spray foam insulation, in particular, is considered harmful and will unlikely be permitted. It could increase the risk of condensation and decay. The foam sticks to the timbers and underside of the roof or tiles. This makes repairs in the future difficult. It is also a permanent installation, and its removal could potentially damage the historic structure.

It is unlikely that external roof insulation will be permitted. The nature of the process would undoubtedly cause harm to the significance and character of the Listed Building. External works to roofs will only be considered when it can be demonstrated that the existing roof is beyond its lifespan and no longer functional.

2.4.2 Internal insulation

Internal insulation is generally carried out by insulating the internal or cavity walls at your home. Most homes constructed after 1920s are likely to have cavity walls, which is a wall with a hollow centre. Older homes are likely to have been built with solid walls. The appropriate method of internal insulation will depend on your wall type. Your home may also already have wall insulation, especially if it is a modern property.

Cavity wall insulation is carried out by injecting insulating materials into the gap in the middle of the wall. However, this may not be possible if the gap is too narrow. Internal wall insulation is carried out by fitting insulating boards to the inside face of your walls, or by building a stud wall and filling it with insulating materials. Internal insulation can vary in thickness. It may be disruptive to the internal appearance of your home as features such as door frames or skirting boards may need to be removed and reattached.

Solid wall

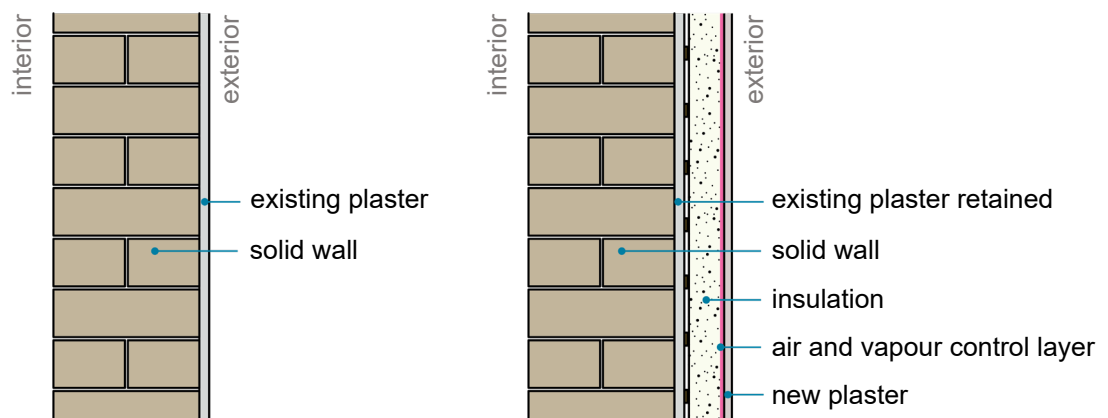

Cavity wall

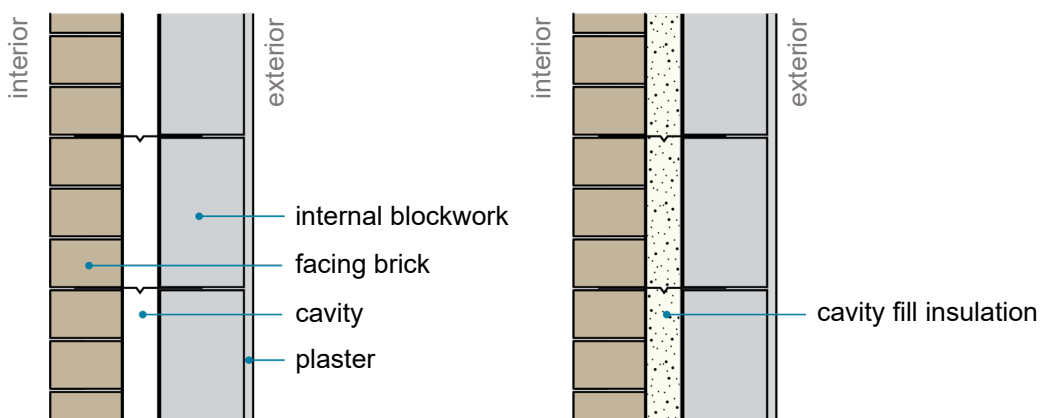

Figure 14: Solid wall and cavity wall insulation

Any internal insulation needs to be carried out by a qualified expert, who can advise on the best solution for your home.

Houses, flats and maisonettes

Planning permission will not be required for any internal insulation in a house, flat or maisonette. Different requirements apply to Listed Buildings, set out in the section below.

If you are a leaseholder, then you may also need to gain permission from the freeholder of the site before being able to carry out the works. The freeholder may also have their own requirements and restrictions on works.

Conservation Areas

Planning permission is not required for any internal insulation in a house, flat or maisonette. Different requirements apply to Listed Buildings, set out in the next section.

Internal insulation is encouraged within Conservation Areas as it does not impact the external façade of your home and preserves the character and appearance of the area.

Listed Buildings

Listed Building Consent is required for any type of internal insulation in Listed Buildings.

The interiors of Listed Buildings are often of great significance. They contain features of architectural or historic interests. Examples include fireplaces, staircases, doors, windows, skirtings and cornices.

We will not permit internal insulation within a Listed Building if it causes harm to original walls or covers any features of significance.

2.4.3. External insulation



We offer a free [pre-application advice](#) service for installing external insulation at your home. You can use this service to discuss the works with a planning officer. This could help resolve any planning policy or design issues before you make your application.

External insulation is generally carried out by cladding your home in a layer of insulation and covering it with a thin render or plaster finish. Brick slips can also be used as a finishing material in certain circumstances.

External insulation is suitable for homes which have an existing render or plaster finish as this appearance can be easily replicated. It also suits homes with solid walls or limited internal floorspace which makes internal insulation challenging. External insulation will likely require pipework and plumbing to be removed and reattached. Window sills will also need to be extended to ensure water runoff is maintained.

Any external insulation needs to be carried out by a qualified expert, who can advise on the best solution for your home.

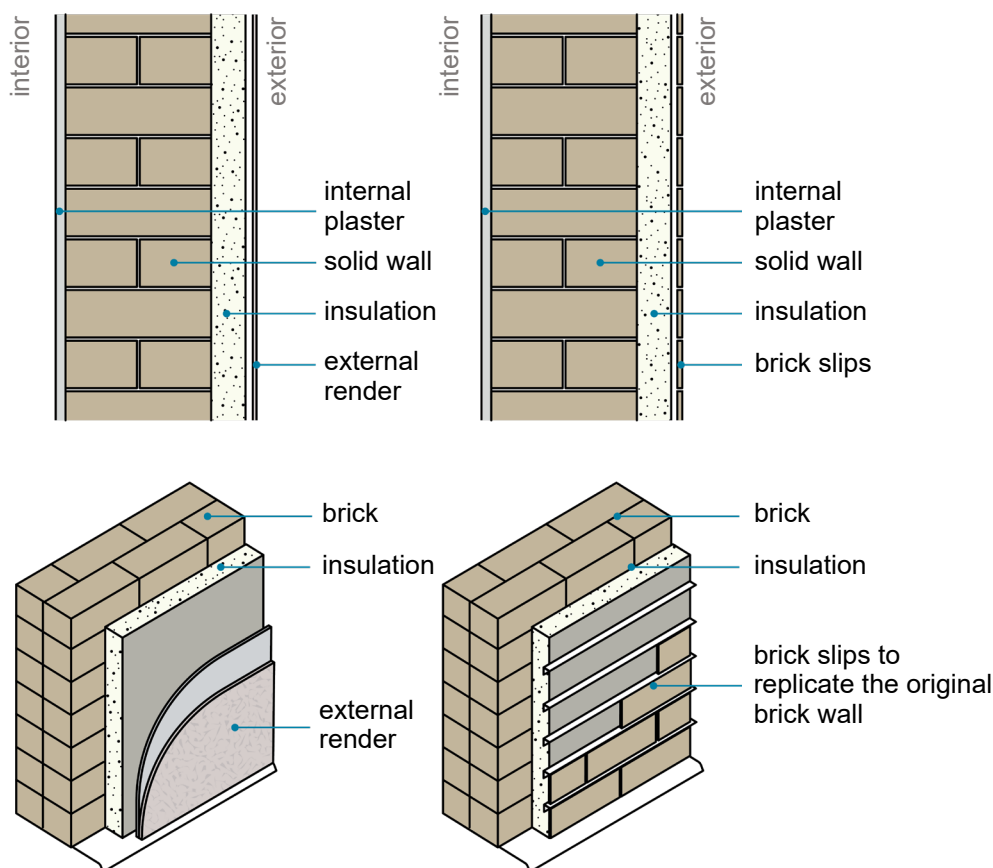

Figure 15: External insulation in render and brick slips

Houses, flats and maisonettes

Planning permission will not be required for any external insulation in a house, flat or maisonette unless the external appearance of your home is changed. For example, planning permission will be required if your home is currently finished in brick but the external insulation will result in a render finish. However, if your home is currently finished in render, no planning permission will be required as the external appearance has remained the same.

Different requirements apply to Listed Buildings and Conservation Areas, set out in the next sections.

If you are a leaseholder, then you may also need to gain permission from the freeholder of the site before being able to carry out the works. The freeholder may also have their own requirements and restrictions on works.

Conservation Areas

You will need planning permission for external insulation within Conservation Areas.

The external appearance of these homes contributes to the historic importance and character of the Conservation Area.

External insulation will not be permitted where the appearance of the building changes. This includes a change in external material or loss of key features. For example, a render finish would not be suitable at a home which is currently finished in brick. This changes the appearance of the building and lessens the design quality of the area.

External insulation is best placed on facades which are already rendered. It may also be acceptable on less visible or rear facades.

Listed Buildings

You will need Listed Building Consent for external insulation. It is unlikely however that external insulation will be permitted.

The external appearance of a listed home is often of great significance and historic interest. Example features include original windows, doors or brickwork. External insulation will cover up such features and harm the significance and character of the building as a result.

As such, other forms of insulation should be considered.

2.5 Air source heat pumps

Is permission required for installing air source heat pumps?

Houses	Flats/Maisonettes	Conservation Area	Listed Buildings
Planning permission is not generally required unless the proposal falls within the list of exceptions of permitted development .	Planning permission is not generally required unless the proposal falls within the list of exceptions of permitted development .	Planning permission is not generally required unless the proposal falls within the list of exceptions of permitted development .	Planning permission and Listed Building Consent are required.

Table 7: 'Is permission required for installing air source heat pumps?'



We offer a free [pre-application advice](#) service for installing air source heat pumps at your home. You can use this service to discuss the works with a planning officer. This could help resolve any planning policy or design issues before you make your application.

Heat pumps run on electricity to provide heating and hot water. The use of heat pumps as opposed to gas boilers can reduce the cost of your heating bills and reduce your carbon footprint.

Heat pumps are only suitable if your home uses radiators or underfloor heating as its main source of heating. Your home will also need to be airtight and well insulated otherwise the heat pump will not be able to operate efficiently and may become very costly to use. You will also need enough space to fit the heat pump units.

There are two common types of heat pumps:

- Ground source heat pump: Pipes are placed under ground. It is only suitable if you have a garden or large outdoor space suitable for digging.
- Air source heat pump (ASHP): The heat pump units are placed above ground. It is suitable if you have sufficient external space to fit the unit(s) and for it to have the necessary amount of open air to function efficiently.

This guidance covers ASHPs only.

ASHPs can be very noisy. They need to be placed at least 1m from the site boundary to limit disruption to adjoining neighbours. The minimum distance may have to increase depending on the layout of your home and proximity to neighbours. Acoustic screens could be installed to reduce noise impact. The cold air discharged from air source heat pumps should not be fed into communal or actively used space.

The ASHP should also be sited sufficiently distanced from any tree root protection areas.

An ASHP should be located to the rear of your home or in areas which already have a service character, away from the principal elevations of the property. It may also be located on the roof of your home. In on the roof, it will need to be set back from the roof edge or preferably behind a parapet to minimise visual impact. ASHPs should be screened with greenery, fencing or an alternative appropriate enclosure where practical.

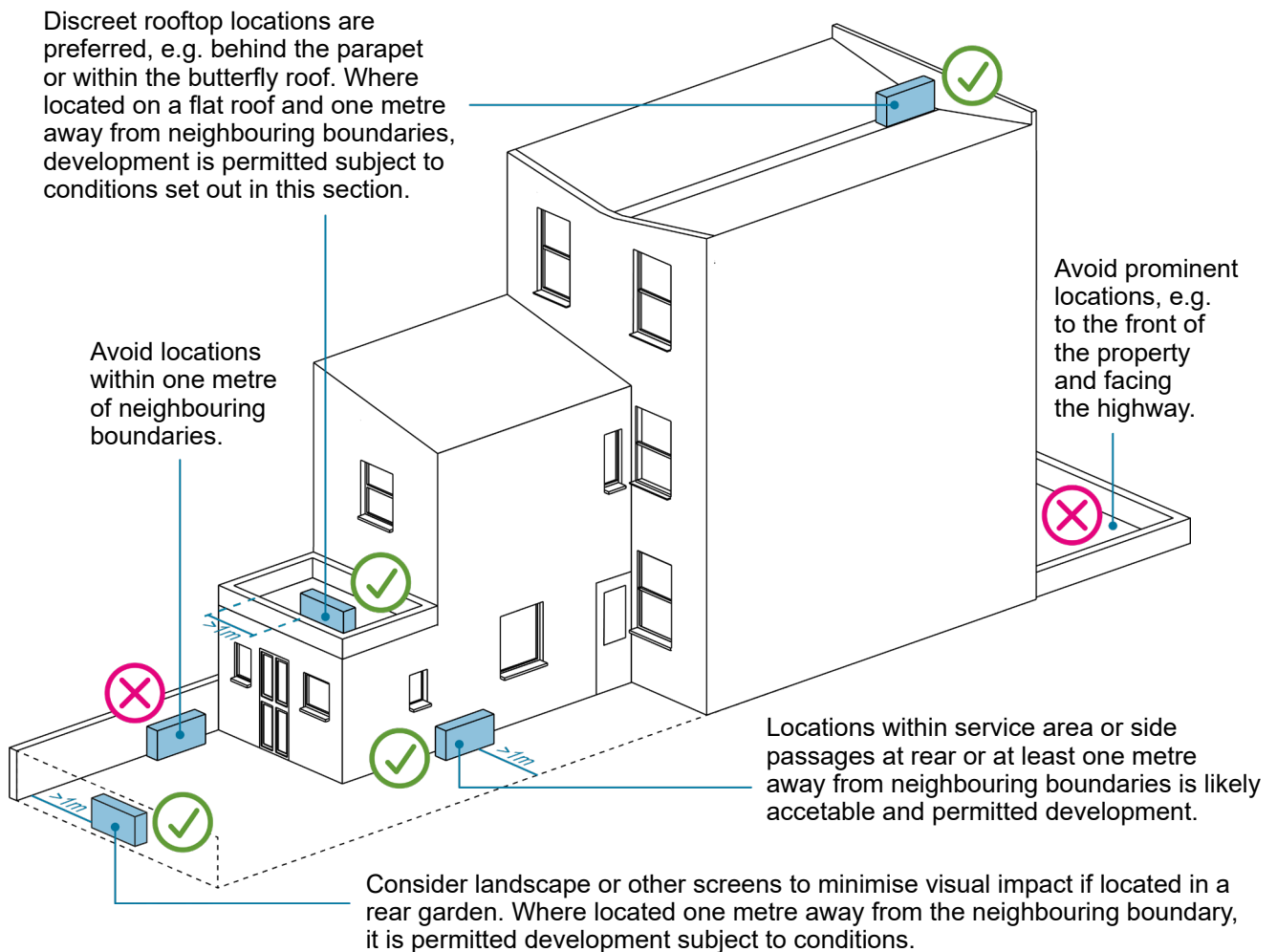

Figure 16: Siting an ASHP

You should consult the relevant experts for the best solution for your home.

Houses, flats and maisonettes or homes within Conservation Areas

The installation of ASHPs is permitted development within houses, flats, maisonettes and homes within Conservation Areas, subject to the following limits:

- Development is permitted only if the ASHP installation complies with the Microgeneration Certification Scheme Planning Standards (MCS 020) or equivalent standards.
- The volume of the ASHP's outdoor compressor unit (including housing) must not exceed 0.6 cubic metres.
- Only the first installation of an ASHP would be permitted development. Additional ASHPs at the same property requires an application for planning permission.
- All parts of the ASHP must be at least one metre from the property boundary.

- Installations on pitched roofs are not permitted development. If installed on a flat roof all parts of the ASHP must be at least one metre from the external edge of that roof.
- Permitted development rights do not apply for installations within the curtilage of a Listed Building or within a site designated as a Scheduled Monument.
- On land within a Conservation Area or World Heritage Site the ASHP must not be installed on a wall or roof which fronts a highway or be nearer to any highway which bounds the property than any part of the building.
- On land that is not within a Conservation Area or World Heritage Site, the ASHP must not be installed on any part of a wall above the level of the ground floor storey if that wall fronts a highway.

The installation of ASHPs is also subject to the following conditions:

- The ASHP should only be used for heating purposes.
- The ASHP should be removed as soon as reasonably practicable when it is no longer required.
- The ASHP should be located, as far as practicable, to minimise its effect on the external appearance of your home and surrounding area.

Different requirements apply to Listed Buildings, set out in the next section.

The need to minimise the visual impact of the ASHP is of particular importance to homes within Conservation Areas. The external appearance of these homes contributes to the historic importance and character of the area. ASHPs can be intrusive as modern features.

ASHPs will not be acceptable if placed within the front garden or street facing roof of a home in a Conservation Area. ASHPs should also not be placed in any other publicly visible area of your home in a Conservation Area.

You will need planning permission if the above limits and conditions cannot be met. You may wish to apply for a Certificate of Lawfulness before installing an ASHP. This will provide a formal confirmation that planning permission is not required.

Listed Buildings

You will need planning permission and Listed Building Consent for the installation of ASHPs if your home is listed.

The benefit of an ASHP will be limited in Listed Buildings that are not insulated or airtight. The necessary pipework and units could also compromise the integrity of the Listed Building.

We do not generally encourage the installation of ASHPs within Listed Buildings. ASHPs may be acceptable if part of a whole-building approach and demonstrating that no harm will be caused to the Listed Building.

2.6 Solar panels

Is permission required for solar panels?

Houses	Flats/Maisonettes	Conservation Area	Listed Buildings
Planning permission is not generally required unless the proposal falls within the list of exceptions of permitted development .	Planning permission is not generally required unless the proposal falls within the list of exceptions of permitted development .	Planning permission is not generally required unless the proposal falls within the list of exceptions of permitted development .	Planning permission and Listed Building Consent are required.

Table 8: 'Is permission required for solar panels?'



We offer a free [pre-application advice service](#) for installing solar panels at your home. You can use this service to discuss the works with a planning officer. This could help resolve any planning policy or design issues before you make your application.

Solar photovoltaic panels (PVs) convert energy from sunlight into electricity to power your home. Solar thermal systems are also available which use the similar technology to provide heating and hot water. Solar panels are most commonly fitted onto roofs and a typical system for a house will produce 5000 kWh per year.

Installing solar panels or solar thermal systems can reduce the cost of your energy bills and reduce the carbon footprint of your house's energy use.

You will need to talk to your energy provider about the most suitable solution for your home and how the generated electricity can be used.

Houses, flats and maisonettes and homes within Conservation Areas

The installation of solar panels is [permitted development](#) within houses, flats and maisonettes or homes within Conservation Areas. However, there are several exceptions and conditions which need to be met, which can be found on the [Planning Portal](#). Different requirements apply to Listed Buildings, detailed in the subsequent section.

If planning permission is required, the following should be included within your application:

- A description of the solar PV and/or solar thermal system you intend to install
- The capacity (electrical output) of the proposed system (KWph)
- The number of solar panels and the area covered by the panels (m²)
- Details on any potential overshadowing from trees, other buildings and roof features.

A [Visual Impact Assessment](#) (VIA) should be included if your home is within a Conservation Area and the solar panels will be visible from a public viewpoint. It should be proportionate to the scale of the proposed works and address:

- How many panels are proposed and how they will be arranged
- How visible the panels will be from public areas
- How the proposed panels have considered the design guidelines set out in [Figure 17](#)

Solar panels can clutter if installed poorly. They may also appear disorderly and harm the character of your home. This is of particular concern if your home is within a Conservation Area. The external and public facing appearance of homes within Conservation Areas often contribute positively to the historic character and significance of the area and should be preserved.

Guidance on where to fit solar panels and ways to minimise their visual impact is provided in [Figure 17](#) on the next page. However, this needs to be balanced with the direction your home is facing to ensure the panels perform efficiently.

Permitted development conditions - Planning permission is required if you fail to meet any of the conditions.

- The solar installation must not protrude more than 0.6 metres beyond the plane of the wall or the roof slope when measured perpendicularly from the external surface of the wall or roof slope.
- The highest part of the installation must not exceed the highest part of the roof (excluding the chimney).

- The solar PV or solar thermal system must not be installed on a site designated as a **scheduled monument**.
- The solar PV or solar thermal system must not be installed on a **Listed Building**, a building within the gardens or grounds of a Listed Building.
- When no longer needed, the installations should be removed as soon as reasonably practicable.
- The installations must be sited, so far as is practicable, to minimise the effect on the external appearance of the building and the visual amenity of the area in which the building is located.

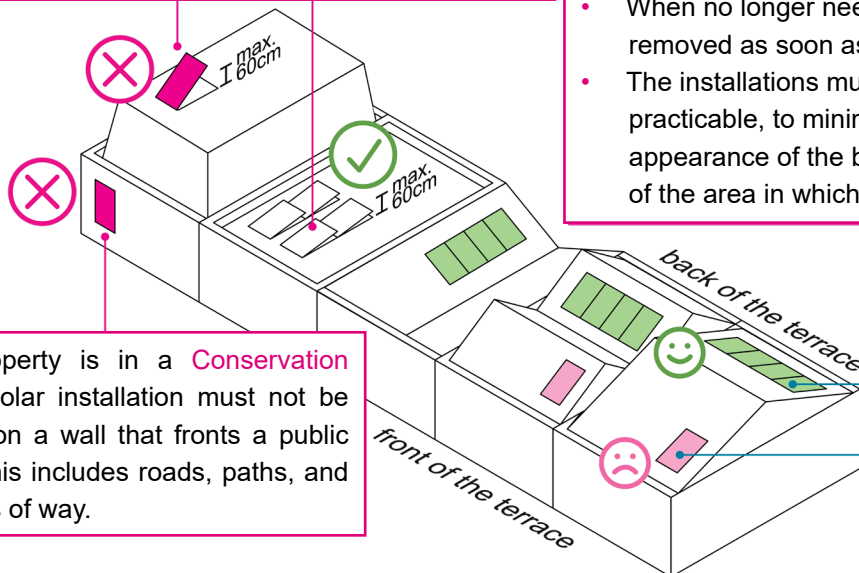

If your property is in a **Conservation Area**, the solar installation must not be positioned on a wall that fronts a public highway. This includes roads, paths, and public rights of way.

Design principles

To minimise visual impact

Position

Install on less visible roofs where possible. Avoid installation on public-facing roofs.

	Do's	Don'ts
Colour & contrast	Colour of the panels should match that of the roof. Frameless panels or panels with painted frames are encouraged. Use low-reflecivity panels to reduce glare.	Avoid untreated cables and frames that contrast with the colour of the roof.
Arrangement	Panels should be well aligned, arranged in the same direction and symmetry. Organise them carefully around roof features if any.	Avoid arranging panels in a mix of horizontal and vertical directions with zero symmetry.
Spacing	Panels should be evenly spaced and set in at least 1m from every edge of the roof and/or wall margins.	Avoid placing panels too close to the roof edges.
Mounting system	In-roof mounting system is encouraged. Panels are integrated as part of the roof instead of sitting on top of the tiles.	Avoid too much gap between the panels and roof surface. It may lead to bird nesting or leaves getting stuck under the panels. Mounting rails should not go beyond the panels.
Neighbouring solar panels	Try to resemble the style of neighbouring solar panels if possible.	Try not to diverge too much from the style of neighbouring solar panels.

Figure 17: Siting solar panels and design principles to minimise visual impact

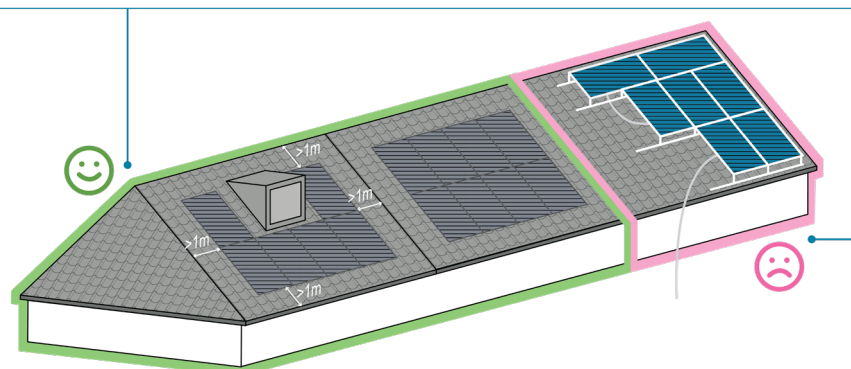

Listed Buildings

Planning permission and Listed Building Consent will be required for the installation of solar panels if your home is listed.

As a modern feature, solar panels are not considered to be sympathetic with many of the Listed Buildings found within the borough. This means solar panels will need to be installed sensitively and in the least disruptive form possible. Solar panels will not be permitted if adverse harm is caused to the visual appearance or historic fabric of the Listed Building.

The external appearance of a Listed Building is often of great importance to its character and significance and should be preserved. Overly visible solar panels would cause harm to a Listed Building's external appearance by introducing an inherently modern feature. Solar panels should be shallow pitched and hidden behind parapets where possible. They may also be placed on sections of the roof which are not visible to the front or rear of your property.

Solar panels may result in the loss of historic fabric as roof tiles may need to be removed for the installation. Although a few tiles may seem minor, these roofs tend to be original and historic feature. They contribute to the character and significance of the Listed Building. Great effort should be made to preserve as much historic fabric as possible. Where new tiles are required, these should be like-for-like replacements.

Ground-mounted solar panels may be a more appropriate solution for a Listed Building. Such will reduce any visual impact and avoid interaction with historic fabric.

You will also need to consider whether your home is listed as part of a group of buildings and the impact solar panels would have on the significance of the wider listed group. Group listing commonly applies to terraced properties, where the whole terrace is included in the listing as opposed to one individual home. If your home is group listed, then you will need to ensure any works maintain consistency across the group and do not introduce features which will detract from the Listed Buildings. You can find out whether your home is group listed in the Listed Building description. It will refer to your property's address or a wider group.

We welcome positive improvements to front garden which promote active design, reduce clutter and improve access to your home, especially for vulnerable residents. This can include providing space for cycle storage or enclosures for recycling and refuse bins.

2.7 Cycle and bin storage

Any cycle or bin enclosure is encouraged to be placed against a side boundary within the front garden, and not impede access to the front door. Storage should be kept away from the front boundary wall with the street where possible. Cycle or bin storage should not open onto the street pavement and should be accessed from within your front garden. This avoids any incursion or interruption into the public highway.

Cycle storage

Cycle storage is encouraged to be fully enclosed, secure and weatherproof and be easily accessible. Cycle storage is also encouraged to be to Sheffield stand specification, which provides the most convenient and accessible form of cycle parking.

Refuse storage

Refuse storage is encouraged be provided in accordance with the council’s “Waste management guidance notes for residential developments” document.

2.8 Off street parking

Is permission required for off-street parking?

Houses	Flats/Maisonettes	Conservation Area	Listed Buildings
Planning permission is not generally required unless the proposal falls within the list of exceptions of permitted development .	Planning permission is required.	Planning permission is required.	Planning permission and Listed Building Consent are required.

Table 9: 'Is permission required for off-street parking?'

An application for residential off-street parking usually consists of three elements:

- Hardstanding area of your home (generally a front garden), large enough to hold a standard vehicle (at least 2.4m x 4.8m)
- A vehicle crossover to enable legal and safe access to your property from the carriageway
- The specified number of parking spaces

2.8.1 Hardstanding

Hardstanding refers to an area which has been paved over with a hard, non-porous material (such as concrete) for car parking. For residential off-street parking, this generally involves paving all or part of the front garden at your home.

Areas of hardstanding are not encouraged in most homes due to the negative impact on front gardens. Greenery and planting are often replaced with hardstanding materials which are less permeable. This increases rainwater run-off as it cannot be absorbed. The removal of greenery and planting also negatively impacts the character of your home (especially in Conservation Areas or listed homes). It can further detract from the appearance of the existing streetscape and impact the visual amenity of the area.

Permitted development allows for 5m² of hardstanding in a front garden. This is often not enough to fit a standard modern vehicle which generally requires 11.5m² of paving on average. You would therefore need planning permission if using hardstanding for the purpose of parking a vehicle. Permitted development does allow for paving of any size if made of a porous material (such as impermeable paving) or if provision is made to direct run-off water to a permeable or porous area.

You will need to apply for planning permission for any hardstanding or non-permeable paving if your home is a flat, maisonette, in a Conservation Area or a Listed Building as permitted development does not apply.

Planning permission may also be required for the necessary vehicle crossover to facilitate the off-street parking on the hardstanding.



Separate permission also needs to be sought from the council's Highways team for all vehicle crossovers.

2.8.2 Vehicle crossovers

Vehicle crossovers generally involve lowering a kerb and allowing for a car to drive across a public road and pavement to access off-street parking.

Vehicle crossovers can cause conflict with pedestrians, bicycles and vehicles by interrupting movement along a street. Vehicle crossovers also remove usable kerbside space, including on-street parking spaces available to all.

Planning permission is required for vehicle crossovers when:

- On classified roads and trunk roads
- Providing access to a property that is a maisonette or divided into flats
- In a Conservation Area
- Providing access to a listed home (permission required alongside Listed Building Consent)

Receiving planning permission does not always mean you can install a vehicle crossover. Permission for all vehicle crossovers need to be sought from the council's Highways team in addition.

There are certain highway features which cannot be moved for a vehicle crossover, such as speed humps or traffic islands. Your application for a vehicle crossover will be refused if any non-moveable features are located outside of your home. Full details of all non-moveable features can be found in [fact box 2](#).

Other features may be moveable, such as on-street electric vehicle charging points or cycle stands. The costs of the relocation would be paid by the applicant seeking the crossover. These costs can be significant and will vary depending on the feature. Your application for a vehicle crossover may still be refused if the relocation of the feature would have an adverse impact on the public highway. Full details of all potentially moveable features can be found in [fact box 3](#).

Further requirements which a vehicle crossover needs to meet are listed in [fact box 4](#).

If a crossover is to be installed, you are encouraged to follow the best practice example set out in [Figure 18](#). This is best practice guidance for all vehicle crossovers, regardless of whether planning permission is required or not.

i

Fact box 2: Non-moveable features

The following list contains items that cannot be relocated or removed to install a vehicle crossover. If any of the below items are located outside of your home, your application for a vehicle crossover will be refused.

Traffic calming features, such as speed humps, raised tables, speed cushions and traffic islands. These are strategically placed for highway safety reasons and would be less effective, or ineffective, if relocated.

Street trees provide canopy cover that cleans our air, soil and water. Street trees also mitigate the urban heat island effect and reduce flood risks. Mature trees cannot be replaced as the amount of canopy cover provided by a new tree would not be a like-for-like replacement.

Street lighting columns cannot be located within 1.2m of the edge of a vehicle crossing due to the risk of impact from vehicles and the resulting safety issues. Relocating a street lighting column is not possible. The council need to ensure even light cover for safety at night. The council also need to prevent light pollution and reduce impacts of lighting on wildlife.

Signage is placed in a specific location to help with wayfinding and to ensure compliance with highways regulations, such as speed limits or Controlled Parking Zones.

Uncontrolled formal crossings for pedestrians, such as zebra crossings. These are situated at points of potential conflict to guide pedestrians to the safest crossing location. These crossings cannot be relocated as this would increase risks to pedestrians.

Controlled formal crossings, such as toucan or puffin crossings. These are located to ensure the transport network can function safely and efficiently. Relocation of a controlled formal crossing for a residential crossover would have a negative impact on the transport network.

Bus stop cages cannot be closer than 10m on the same side of the street from a new vehicle crossover. As the Highway Authority, the council has the right to extend this distance if the frequency of bus services or the number of queuing passengers warrants it. Relocating a bus stop cage could have a negative impact on the local transport network.

Blue Badge bays are located to be accessible to residents from specific properties. Relocating a Blue Badge Bay would not be acceptable due to the difficulties it may cause to Blue Badge Holders.



Fact box 3: Potentially moveable features

The following list contains items that could potentially be relocated to facilitate a vehicle crossover. The costs of the relocation would be paid by the applicant seeking the crossover. These costs can be significant and may include but is not limited to the Traffic Management Order (TMO). Your application for a vehicle crossover may still be refused if the relocation of the feature would have an adverse impact on the public highway.

On-street electric vehicle charging points (EVCPs)

- May be moved within the immediate vicinity of their existing location.
- This is only in instances where the move would not have a negative impact on residents.
- Relocation would be subject to consultation during which other residents may raise objections.
- The applicant would bear all costs associated with relocating the EVCP. This would include the TMO and movement of the parking bay associated with the charger.

Standard parking bays

- Can be moved or removed where parking stress in the vicinity of the site is demonstrated to be lower than 85%.
- Relocation would be subject to consultation during which other residents may raise objections.
- The applicant would bear all costs associated with moving or removing the parking bay. This would include the TMO and the signing / lining of the relocated bay.
- The applicant may also be liable for financial compensation that covers the loss of council parking revenue.
- The council may refuse an application where the parking bay would provide valuable kerbside space for uses that benefit the wider public.

On-carriageway cycle hangers

- Can be moved only where there is an appropriate location for the replacement(s) in the vicinity of the site. Users of the hanger must also not be inconvenienced by the relocation.
- Relocation would be subject to consultation during which other residents may raise objections.
- The applicant would bear all costs associated with moving the cycle hanger. This would include the TMO.
- An agreement with the users of the existing hanger must be in place to ensure there is no loss of access or displaced cycles.

Cycle stands on footways

- Can be moved only where there is an appropriate location for the replacement(s) in the vicinity of the site.
- If there is no suitable location for the replacement, the council will likely refuse your application to ensure adequate cover of visitor cycle parking throughout the borough.
- The applicant would bear all costs associated with relocating the cycle stand.

Segregated cycle lanes or tracks

- Can be adjusted where the council deem appropriate, considering the adopted Streets for People strategy which prioritises active travel over private vehicles.
- The applicant would bear all costs associated with relocating the cycle stand. This would include a level 1 departure, a road safety audit (RSA) and TMO. This would likely be a significant expense.



Fact box 4: Highway requirements for vehicle crossovers

Proximity to side roads – New vehicle crossovers cannot not be located within 15m of a side road junction to the same side of the street. On classified roads (A, B and C roads) the minimum distance is 24m.

Consecutive crossovers – Less than 1.2m length of standard footway between crossovers, including between the proposed crossover and existing crossover(s), would be considered unacceptable. This is because frequent changes in crossfall and gradient cause difficulties for those with visual or mobility impairments.

Cross and Long-falls - Measured across the footway, the crossfall gradient should be between 1:30 - 1:60 (1:40 preferred). Gradients should not exceed 1/12 to ensure the safety of pedestrians and a gradient steeper than ¼ will not be permitted.

Visibility splays – Pedestrian sightlines of 1.5m x 1.5m are required either side of the opening in the boundary for a vehicle access from the back edge of the public highway (not within the opening). No features higher than 0.6m are permitted within this area. Vehicle sightlines of 2.4m x 25m (20mph roads) or 2.4, x 43m (30mph roads) are also required.

Entry and exit – On Classified roads, vehicles must be able to enter and exit in forward gear. To reduce conflict between road users, only 1 crossover per residential property will be permitted.

Space for 2.4 x 4.8 car – There must be at least 2.4 x 4.8m of hardstanding or permeable material per car parking space. Gates must open inwards or slide to the side within the bounds of your property. Where gates are proposed to open inwards, additional length of hardstanding is required ensure gates can open while the vehicle is parked.

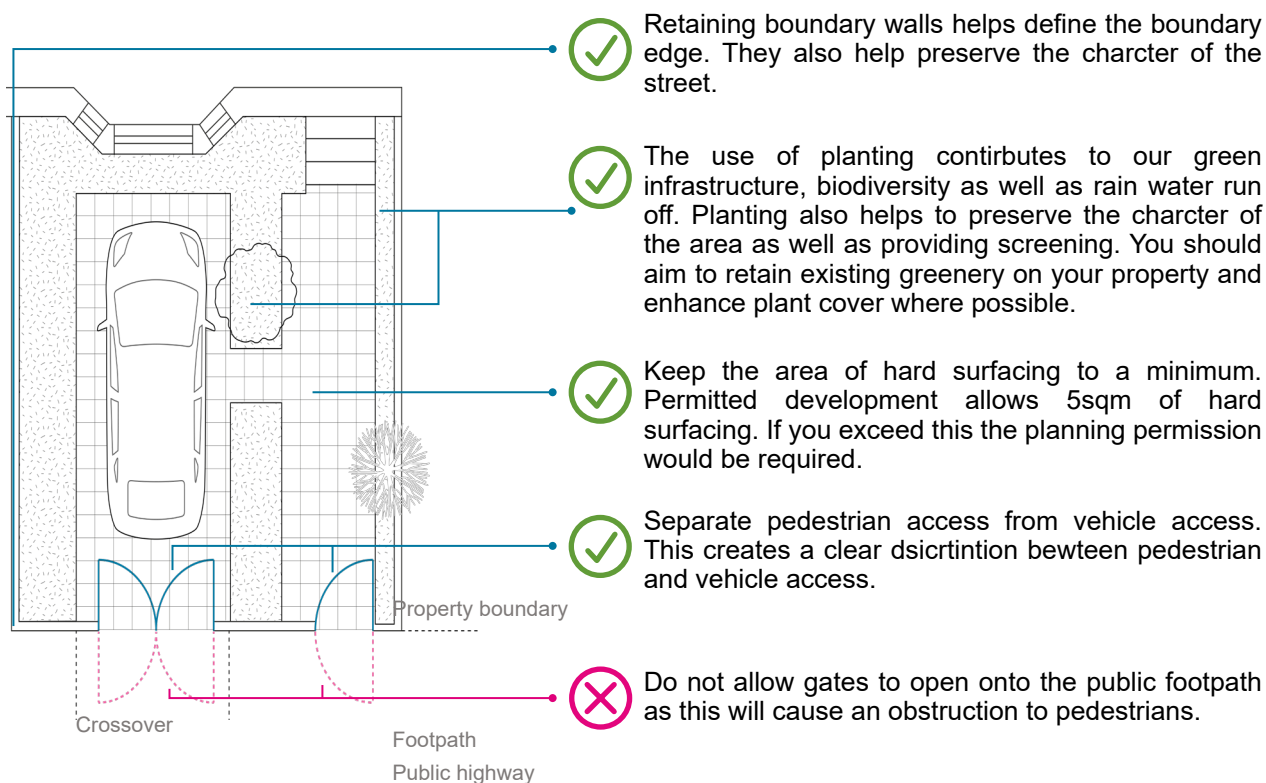

Figure 18: Best practice design guidance on vehicle crossovers

Electric vehicle charging points

You should check whether you can have off-street parking before installing any electric vehicle charging points. For more [information on electric vehicle charging points](#) please refer to the council's website.

2.9 External painting

Is permission required for external painting?

Houses	Flats/Maisonettes	Conservation Area	Listed Buildings
Planning permission is not required.	Planning permission is not required.	Planning permission is not required unless the external appearance will change significantly.	Listed Building Consent is not required unless your home is not currently painted, or the external appearance will change significantly.

Table 10: 'Is permission required for external painting?'

Regular external redecoration can help prevent decay at your home. You may also wish to repaint your home a different colour. In most cases, planning permission is not required unless the permitted development right is removed by an Article 4 Direction.

Conservation Areas

We encourage the use of traditional colours when you are painting your home in a Conservation Area. There may be conventions of using brighter colours in certain areas of the borough or the use of the same colour in a terrace. You are advised to consider local approaches before planning any works, detailed in our [Conservation Area appraisals](#).

Listed Buildings

Listed Building Consent is not required if you are carrying out like-for-like repainting. This means your home is already painted, and you are reapplying the same colour for regular maintenance.

Listed Building Consent will be required if you wish to paint non-painted external areas – for example brick, stone or concrete. Consent will also be required if the external appearance is changing colour – for example from cream to dark grey.

Decisions will be made on a case-by-case basis, but we generally do not support change to the exterior of a Listed Building. Painting brick, stone or concrete walls should be avoided as it could create damp issues and is considered harmful to the historic fabric. On buildings with external coatings, e.g. stucco and lime render, ‘breathable’ paint such as limewash should be used to ensure moisture in walls can evaporate.

2.10 Other development

2.10.1 Boundary walls and fences

Planning permission would not be required if you want to erect a wall or fence, alter or take down an existing wall or fence if you ensure that you meet the following conditions:

- At the front of the property does not exceed 1m in height from ground level
- To the rear of the property does not exceed 2m in height from ground level

Beyond this, planning permission would be required. Listed Building Consent may be required if your home is listed depending on the type of boundary wall or fence proposed to be replaced.

2.10.2 Decking and hardstanding

Decking and hardstanding should be no more than 300mm/30cm above the ground and cannot cover more than 50% of the rear garden at your home.

CHAPTER 3

EXTENSIONS

3 EXTENSIONS

3.1 Introduction

This chapter sets out the works a resident can consider when looking to extend their home. Guidance is provided on the most common types of extensions for residential properties as well as other works such as roof terraces and outbuildings.

This chapter also provides guidance on any relevant planning considerations. These could include design quality, impact on neighbouring properties, and impact on heritage assets (such as Listed Buildings and Conservation Areas).

Some extensions are [permitted development](#) subject to conditions and limitations. This guidance should be read alongside the Permitted Development (Town and Country Planning (General Permitted Development) (England) Order 2015 (as amended). It is your responsibility to ensure you comply with all the legal requirements. The SPD sets out the position accurately in May 2024.

You will need professional advice before you plan an extension to your home. An architect, architectural designer, or surveyor will be able to prepare plans and advise you on the costs involved.

3.2 Key considerations

There may be many factors which need to be considered before planning how to extend your home. This will depend on the type of property you live in and where it is located.

3.2.1 Whole Building Approach

We encourage a 'Whole Building Approach' when looking to extend your home. Planning an extension is a useful opportunity to consider where improvements could be made to your existing home. This could help improve your home's overall energy and thermal performance.

You should consider how your extension plans work with any future ideas for other improvement works. This could be insulating your home, installing heat pumps or solar panels. It would be useful to have an idea of these works so you can future proof your extension plans. Guidance on these works is set out in Chapter 2.

We also encourage energy efficient design and construction. Ways to reduce the carbon

emissions of your extension are best considered at the start of the design process. This could include the use of sustainable materials, green roofs or potential for natural cooling or heating in the extension. You should think about the lifespan of the materials you are using and whether they can be repaired, replaced or recycled in future.

Figure 19 below demonstrates a Whole Building Approach to extending your home. The approach shows which parts of your home to consider first and how to think about the design and construction of your extension. This can also help make your home more resilient to the effects of a changing climate.

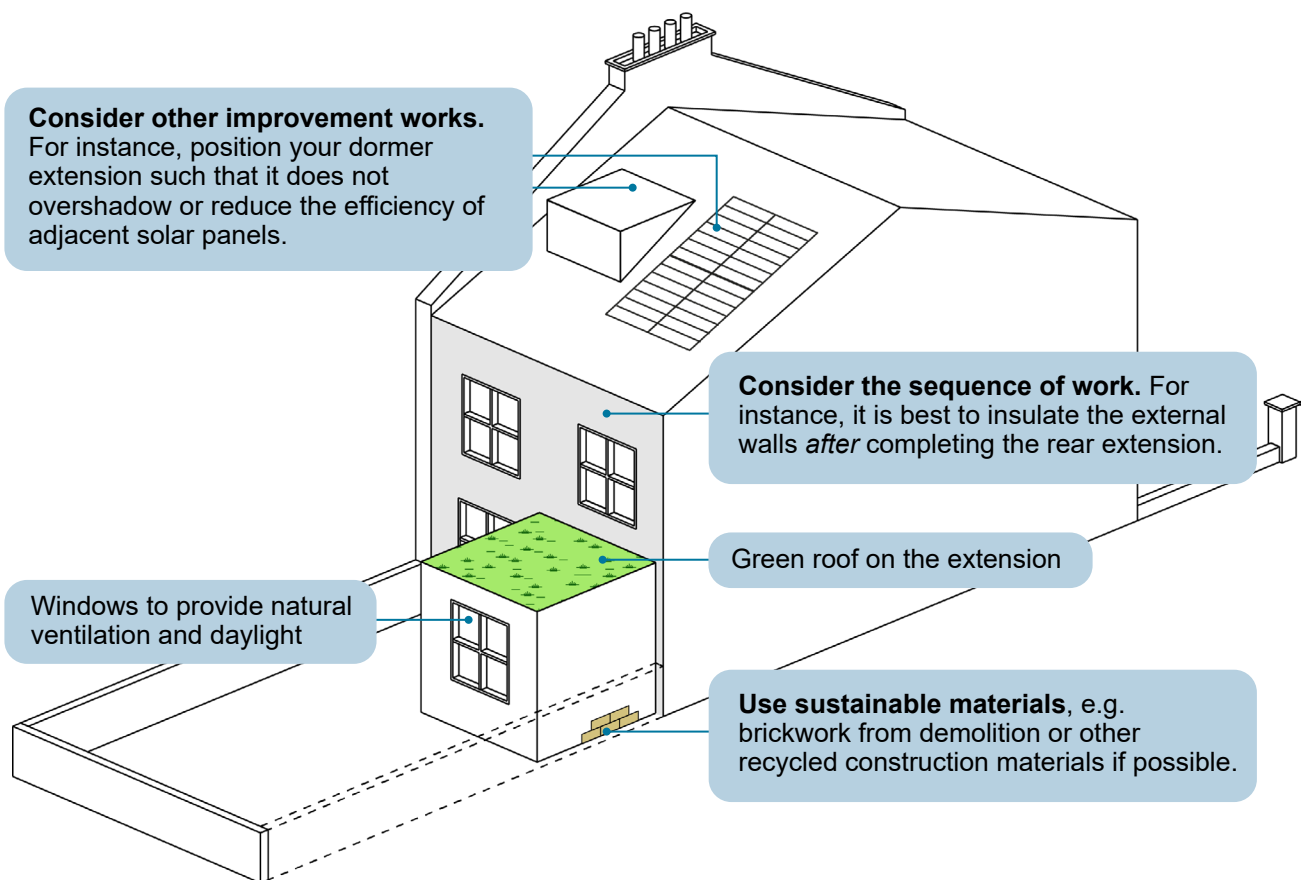

Figure 19: Whole building approach for extensions

3.2.2 Design and appearance

There are many different types of homes in Southwark which show the rich and varied architecture in the borough. Each type of home has its own distinctive features which define its character and style. Whether it a house, a flat, a historic or modern building, features such as windows, doors, the roof or other materials will contribute to a home's appearance.

An efficient and cost-effective extension can work in harmony with your existing home and provide more space where you need it. An extension can also be designed to bring more light and air into your home, providing a better connection to the outdoors.

You should not only consider the type of extension you want but how the extension will relate to your property, as well as the surrounding area.

An extension should:

- Be in keeping with the architectural style of your home
- Be of a size and scale that would not visually dominate your home
- Use materials that are similar to your home
- Be in keeping with the character of the surrounding area, including any historic pattern
- Avoid impact to the amenity of neighbouring properties
- Prioritise energy efficient design and climate resilient construction where practical

3.2.3 Internal space standards

There are no minimum area standards for internal spaces within a residential extension. These only apply to the creation of new dwellings.

Nonetheless, we encourage you to follow the room areas outlined in [table 11](#). This will ensure your home remains enjoyable and liveable, with a high quality of accommodation.

Dwelling size	Studio	1 bed	2 bed	3 bed	4 bed
Double bedroom	N/A	12	12	12	12
Single room	N/A		7	7	7
Living room (where eating area is in the lounge)	N/A	16	17	18	19
Kitchen (where eating area is in the lounge)	N/A	6	7	8	8
Kitchen diner (where eating area is in the kitchen)	N/A	9	11	11	12
Living room (where eating area is in the kitchen diner)	N/A	13	13	15	15
Open plan development (where kitchen/diner is combined with the living room)	N/A	24	27	30	N/A
Bathroom/WC (combined)	3.5	3.5	3.5	3.5	3.5

Table 11: Minimum room areas recommended in square metres

3.2.4 Heritage assets

Additional consideration will need to be given if your home is listed or within a Conservation Area. An extension should be of a high-quality design and be sympathetic to your home.

Your extension can be of a modern design, but the use of traditional materials is still encouraged. This includes materials such as brick, slate or timber. These materials will help reference the historic character of your home or the surrounding area. Traditional materials also tend to last longer than modern substitutes, giving better value and being more sustainable over time.

UPVC (Unplasticized Polyvinyl Chloride) will not be permitted in any of our Listed Buildings or Conservation Areas, even to the rear of a property. UPVC generally appears out of place in historic buildings or areas, owing to the plastic appearance. UPVC may also weather or behave differently from natural and more traditional materials.

Conservation Areas

You should read the [Conservation Area appraisal](#) for your area before planning any works. This sets out the type of materials you should use and the common types of developments for your area.

Listed Buildings

The external appearance of a Listed Building is often of great importance and significance. Any extension should be sympathetic and subservient to your home, and not detract from its external appearance or its historic features.

You will need to consider any historic features of your home, such as whether you have an outrigger or butterfly roof. This may dictate the type of extensions which are possible. We will resist the loss of butterfly roofs and other prominent historic features.

The internal walls and plan form are also very important and reflect the domestic history of a home. These are often not referenced in Listed Building descriptions but are protected by the listed status of the property. You will need to consider the amount of building fabric which needs to be removed to build an extension. This includes any windows, doors, internal walls or chimney breasts. The removal of these features will be considered under the Listed Building Consent.

We will not permit the removal of internal walls where it results in the loss of the original plan form of your home. This means we will not generally allow the whole removal of internal walls to create an open plan living room / kitchen / dining room. We may allow partial removal of walls where there is a retention of wall nibs and down stands. This allows the original plan form to still be legible whilst opening the room up. The loss of other original features such as chimney breasts will also be resisted.

You will also need to check whether your home is listed as part of a group of buildings. If so, you will need to consider the impact any works would have on the significance of the wider listed group. You can find out whether your home is group listed in the Listed Building description. The description will refer to your property's address on its own or part of a wider group. Even if your home is not group listed, it is worth having consideration to any other Listed Buildings in the vicinity of your property.

3.2.5 Trees

You must consider how the any planned extension may impact any nearby trees. This not only includes trees on your property but also those nearby in neighbouring properties. Extensions which involve works to the ground may cause harm to the root protection area of a tree or a tree may have to be removed to clear space for the work. The root protection area of a tree (RPA) is calculated at 12 x the diameter of the tree, measured at 1.5m from the ground. For example, a 300mm diameter tree will have an RPA radius of 3.6m from the bole of the tree, expressed as a circle. This is demonstrated in [Figure 20](#).

If you are pruning, removing or carrying out works that may affect trees (including excavation) you will need to submit a Tree survey or Arboricultural Impacts Assessment as part of your planning application. More information on the assessment can be found [here](#).

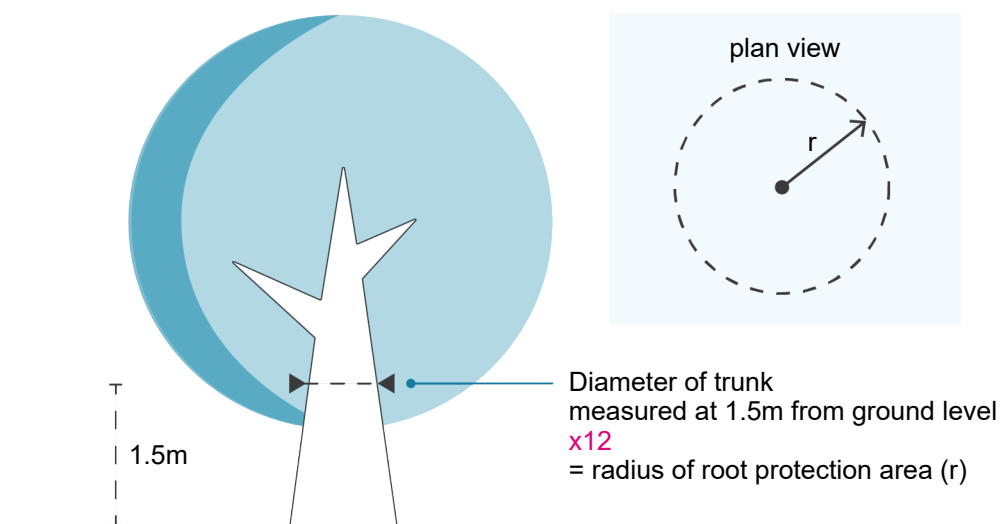

Figure 20: Root protection area of a tree

3.2.6 Impact to neighbouring properties

You must ensure any proposed extension does not negatively impact on your neighbour's ability to enjoy their home.

There are three main factors which are used to assess whether a neighbour is adversely affected:

- Daylight and Sunlight: Proposed works should not cause unacceptable harm the amount of daylight or sunlight your neighbour has access to.
- Privacy: Proposed works should protect the privacy for your neighbour
- Loss of Outlook: Proposed works should not unacceptably harm outlook for neighbours.

Daylight and sunlight tests

We carry out two daylight and sunlight tests when assessing a planning application for an extension. This is to ensure the extension does not cause unacceptable harm to the daylight or sunlight your neighbour has access to.

These tests are the 45-degree rule and 25-degree rule. It is recommended that you carry out these tests before submitting your plans to ensure the extension is compliant.

45-degree rule

We use this test should where the proposed development is at right angles to the affected window of the neighbouring property:

- Draw a line at 45 degrees upwards from the centre of the affected window
- Draw a line at 45 degrees sideways from the centre of the affected window

This test is demonstrated in **Figure 21** below.

If the proposed development is both higher and wider than these 45-degree lines, there may be an unacceptable loss of daylight to the affected window.

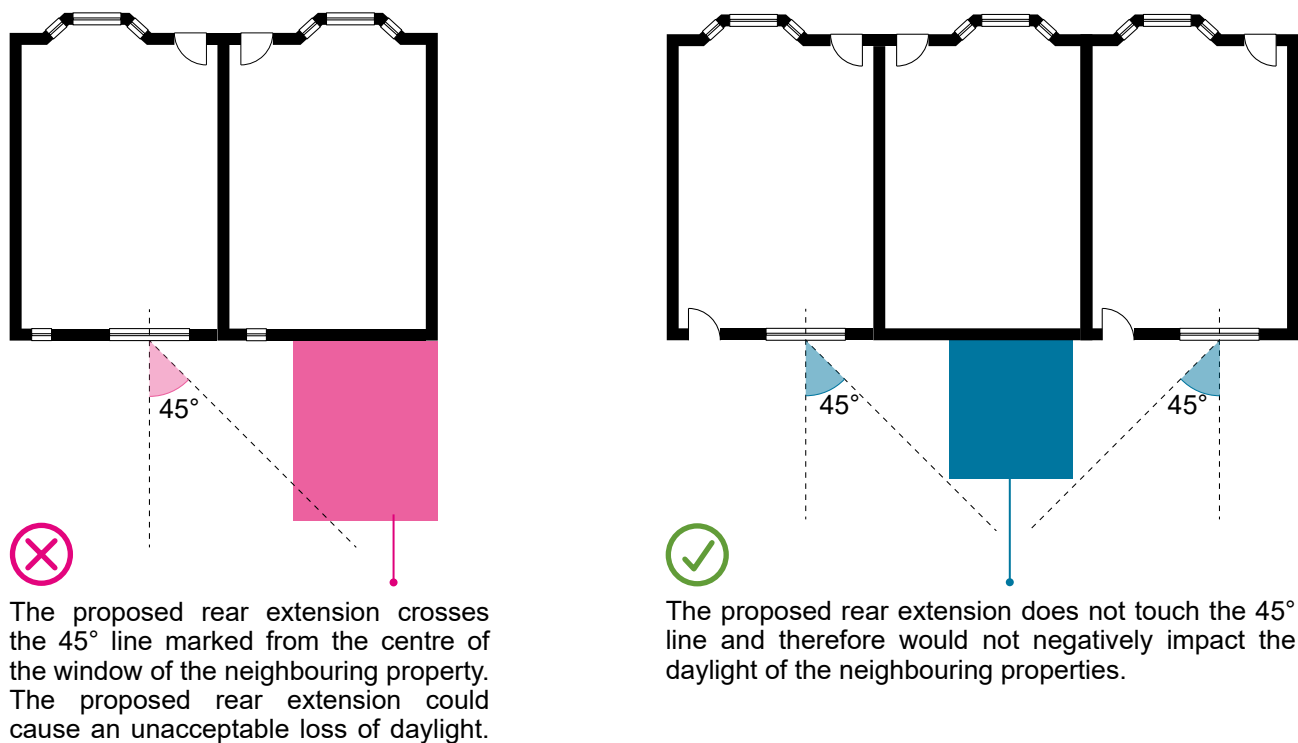

Figure 21: 45-degree rule

25-degree rule

We use this test where the proposed extension faces the affected window of the neighbouring property:

- Draw a line at 25 degrees upwards from the centre of the affected window

If the proposed extension is higher than this 25-degree line, there may be an unacceptable loss of daylight to the affected window.

This test is demonstrated in **Figure 22** below.

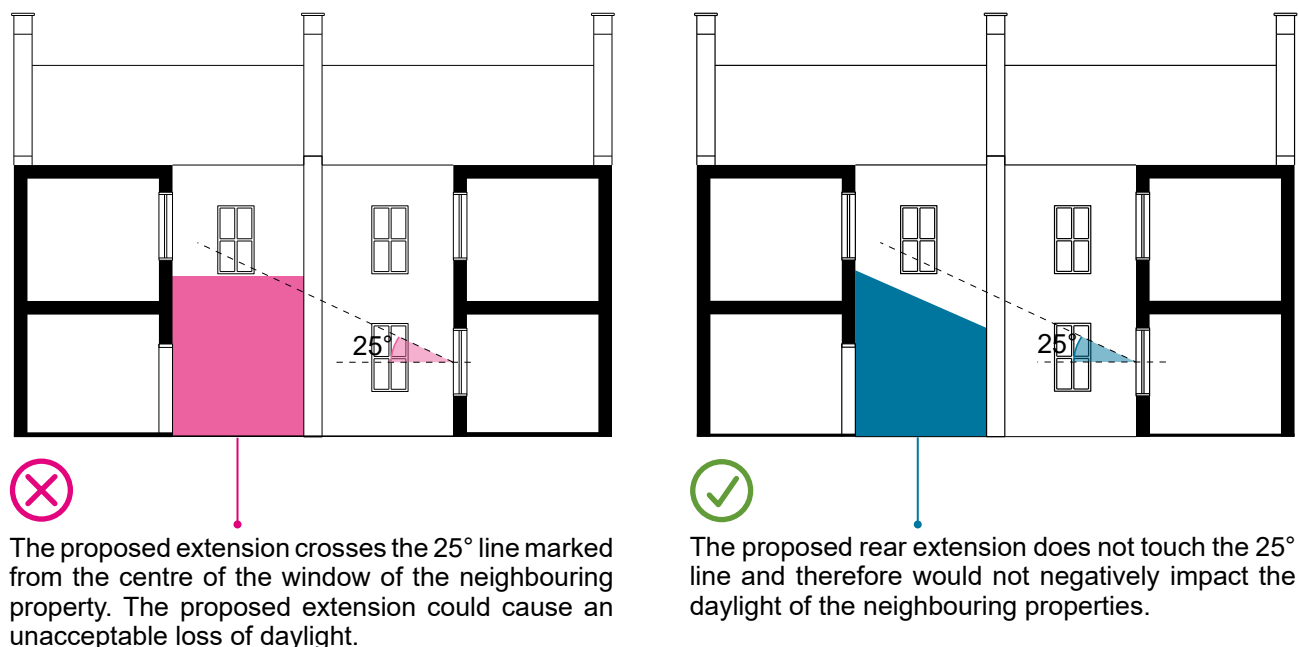

Figure 22: 25-degree rule

3.2.7 Party walls

A party wall is a wall shared by two adjoining properties. Depending on the type of home you live in, you may share may have party walls with more than one neighbour. The Party Wall Act 1996 is in place to control development on each side of a party wall and maintain its integrity and function.

Certain works may need a Party Wall Agreement with your neighbour(s). This is separate from any planning permission you may receive.

3.3 Front extensions

Is permission required for a front extension?

Houses	Flats/Maisonettes	Conservation Area	Listed Buildings
Permitted development applies within certain dimensions. Above this, Planning Permission will be required.	Planning Permission will be required.	Planning Permission will be required.	Listed Building Consent and Planning Permission will be required.

Table 12: 'Is permission required for a front extension?'

Front extensions are generally limited to porches for most properties within the borough. Permitted development allows for the construction of a front porch to a maximum of 3sqm in area and 3m in height. This is shown in [Figure 23](#) below.

Beyond these dimensions, you will need planning permission. Planning permission is also required for front extensions if your home is a flat / maisonette or within a Conservation Area. It is also needed alongside Listed Building Consent for listed homes.

We do not encourage front extensions which exceed these permitted development dimensions as the extension would likely be too visible in the existing street scene. Overly large front extensions can impact the character and appearance of your home.

It is also important to maintain the established building line in your street. This ensures a consistency to the area. Front extensions will not be permitted where this building line is significantly disrupted. This would result in a discordant feature within the streetscape.

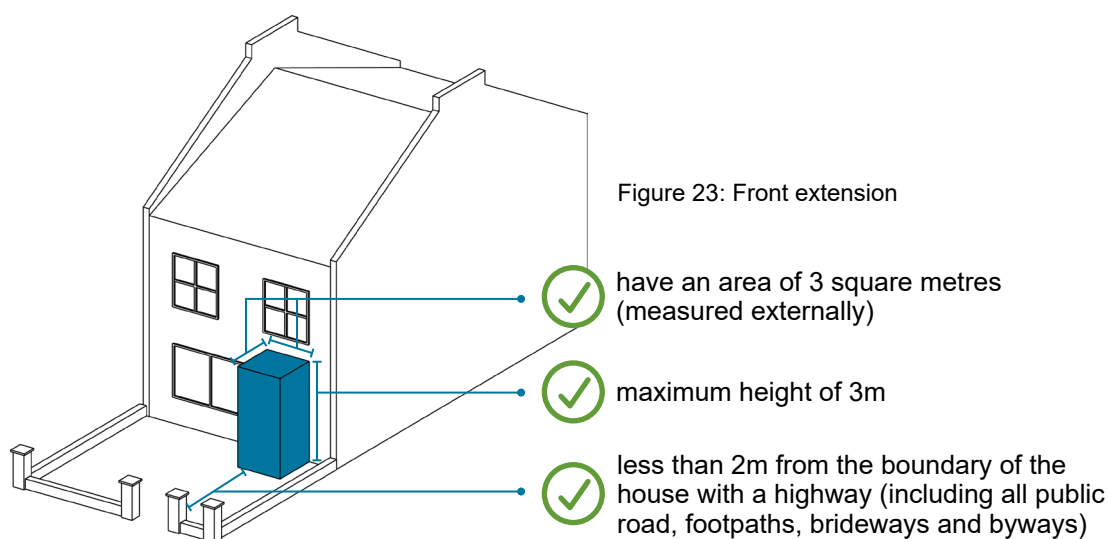

3.4 Side extensions

Is permission required for a side extension?

Houses	Flats/Maisonettes	Conservation Area	Listed Buildings
Permitted development applies within certain dimensions. Above this, Planning Permission will be required.	Planning Permission will be required.	Planning Permission will be required.	Listed Building Consent and Planning Permission will be required.

Table 13: 'Is permission required for a side extension?'

Side extensions are commonly found at detached and semi-detached properties as well as the end of terraces. Consideration needs to be given when planning a side extension to maintain the sense of openness between buildings. This is important for maintaining the character of the existing street scene. It also reduces the sense of enclosure in the area.

Side extensions should be subservient to the existing building and not be a dominating feature. This is especially important if your home is listed or within a Conservation Area.

3.4.1 Single storey side extension(s)

Permitted development allows a single storey side extensions with a maximum height of 4m. The width should be no more than half the width of your home.

Beyond these dimensions, you will need planning permission. Planning permission is also required for front extensions if your home is a flat / maisonette or within a Conservation Area. It is also needed alongside Listed Building Consent for listed homes.

Where planning permission is required, side extensions should still be kept to a single storey. The extension should also be set back from the street-facing façade of the property by 1.5m. This will ensure the important gaps and sense of openness between properties are maintained.

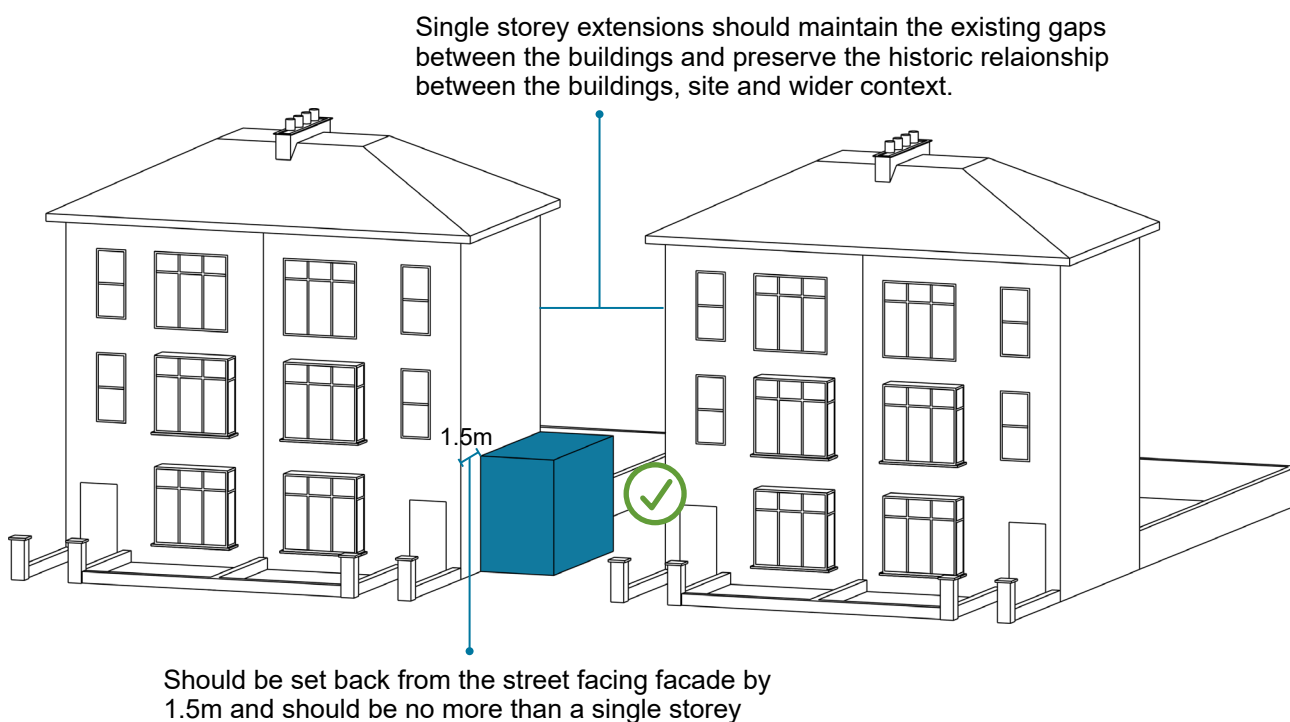

Figure 24: Single storey side extension

3.4.2 Two Storey Side Extension(s)

Two storey side extensions are not encouraged. The two-storey height is likely to have an impact on the character and setting of the street. Two storey side extensions must be designed to avoid a terracing effect, or the loss of the open character between properties. The extension should also be proposed with a roof style to match the existing property, as set out in **Figure 25**.

For houses in conservation areas and listed buildings, it is important to maintain the gaps between buildings. Two storey side extensions fail to maintain the established gap between the buildings.

For houses outside conservation areas and that are not listed, when a two storey side extension is proposed, the roof form should match that of the existing building.

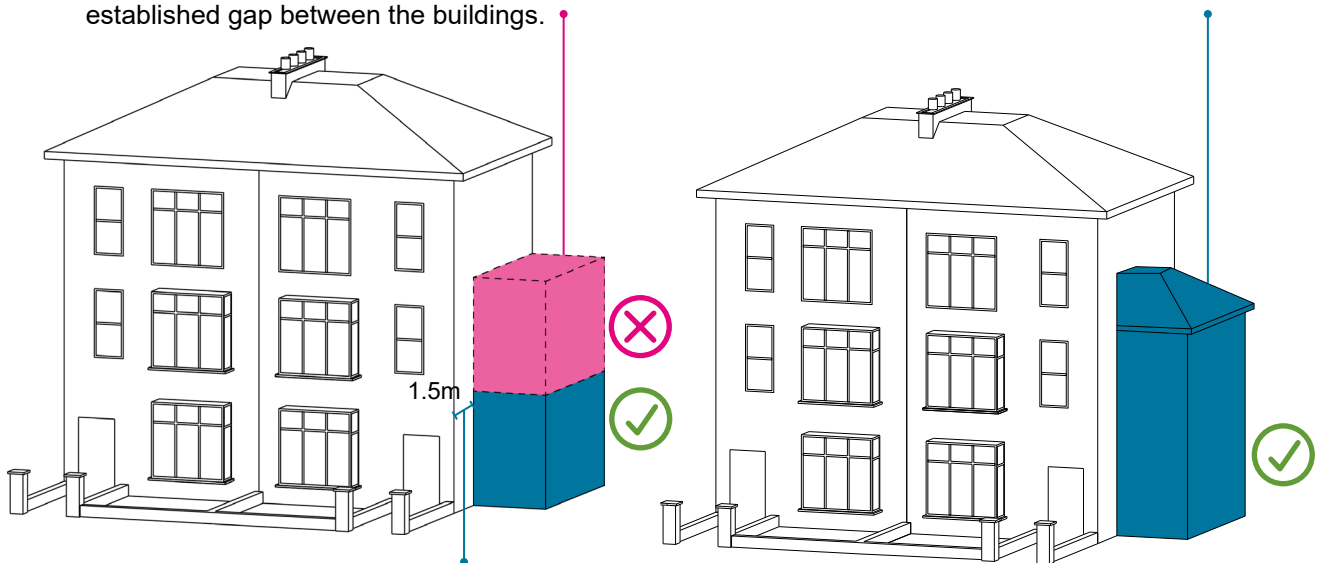

Should be set back from the street facing facade by 1.5m and should be no more than a single storey

Figure 25: Two storey side extension

3.5 Rear extensions

Is permission required for a rear extension?

Houses	Flats/Maisonettes	Conservation Area	Listed Buildings
Permitted development applies within certain dimensions. Above this, Planning Permission will be required.	Planning Permission will be required.	Planning Permission will be required.	Listed Building Consent and Planning Permission will be required.

Table 14: 'Is permission required for a rear extension?'

Rear extensions are suitable for most housing types whether terraced, semi-detached or detached. Rear extensions should be designed to respect the character and scale of your existing home and are encouraged to be kept to a single storey.

You need to consider any change in ground levels between your home and any adjoining neighbours. This may result in the height of your extension appearing taller at these boundaries.

You will also need to ensure any extension does not cause unacceptable harm to the amenity of your neighbours. This guidance is set out in more detail in [section 3.2.6](#).

3.5.1 Permitted development rear extensions

Permitted development allows for some homes to build a single storey rear extension without planning permission.

This is not applicable to homes which are flats, maisonettes, in a Conservation Area or listed.

Terraced and semi-detached house

A terraced or semi-detached home can be extended to the rear by up to 3m in depth and a maximum height of 4m (maximum height at the eaves of 3m), as set out in [Figures 26 and 27](#).

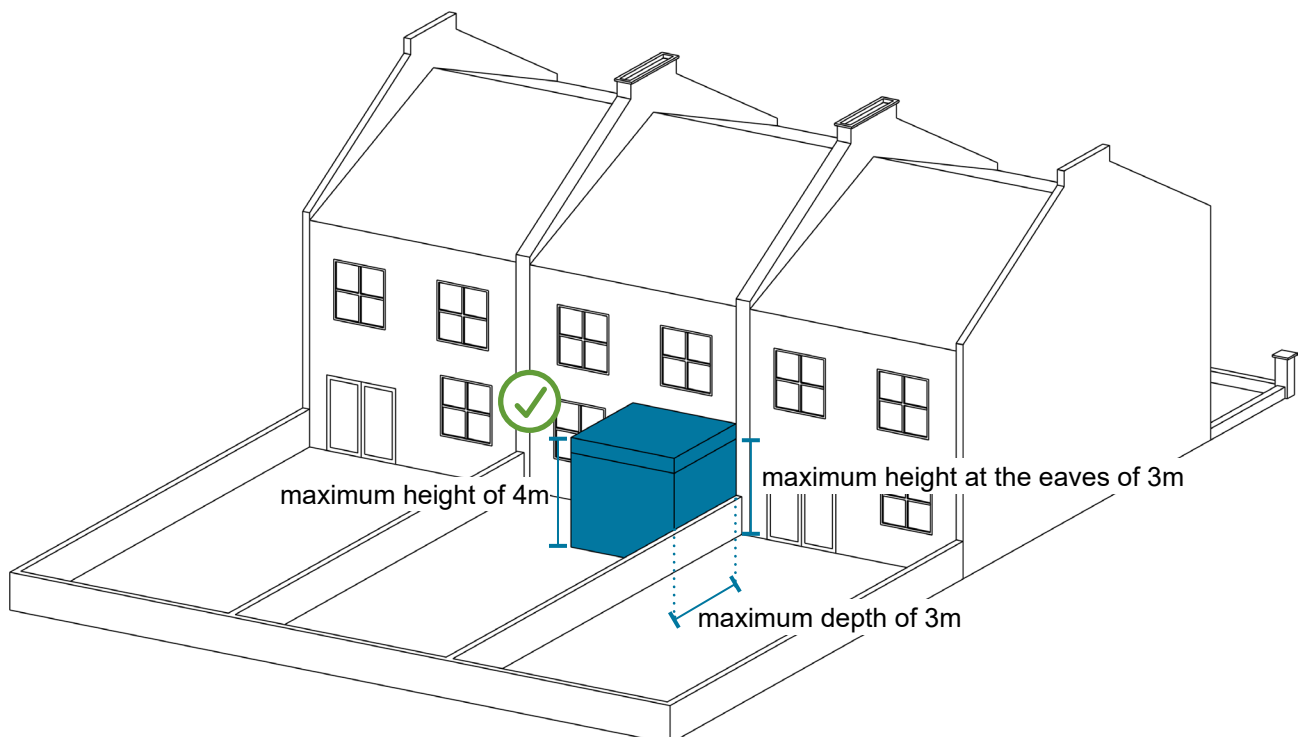

Figure 26: Rear extension at a terraced house

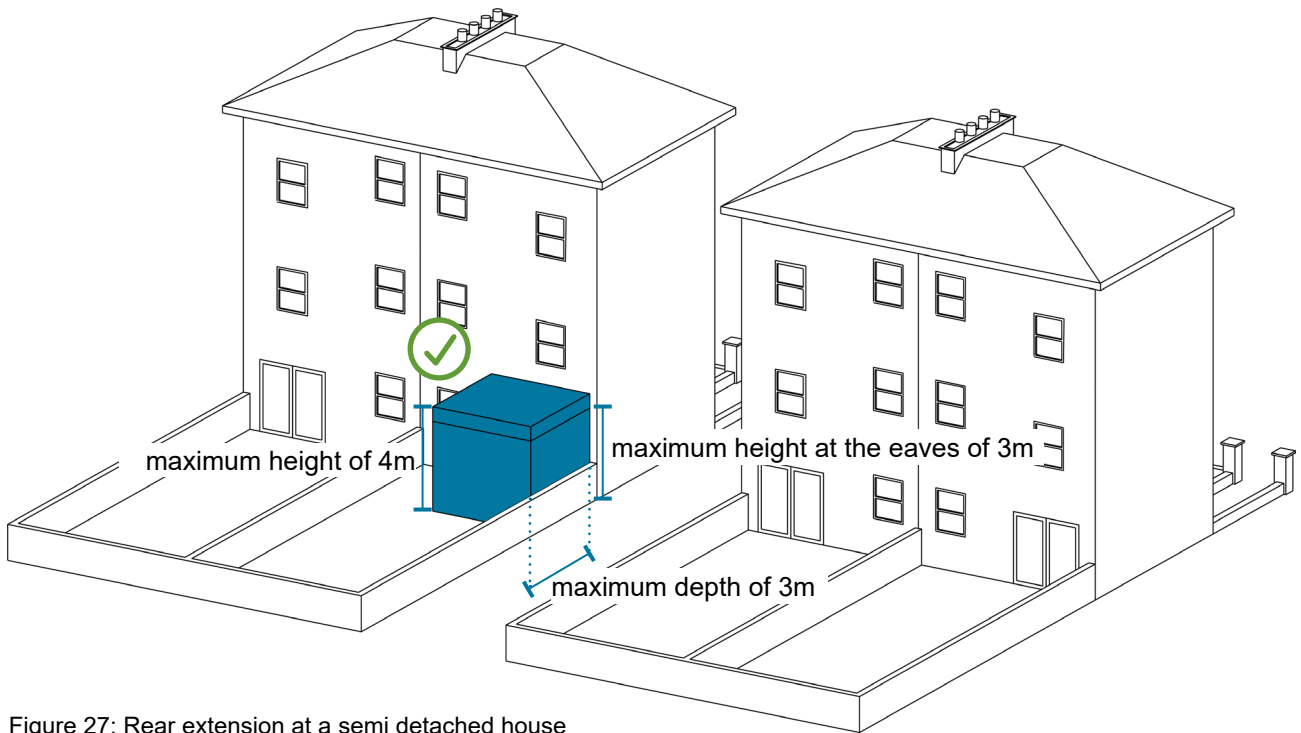

Figure 27: Rear extension at a semi detached house

Detached house

A detached house can be extended to the rear by up to 4m in depth with a maximum height of 4m (maximum height at the eaves of 3m) as set out in [Figure 28](#).

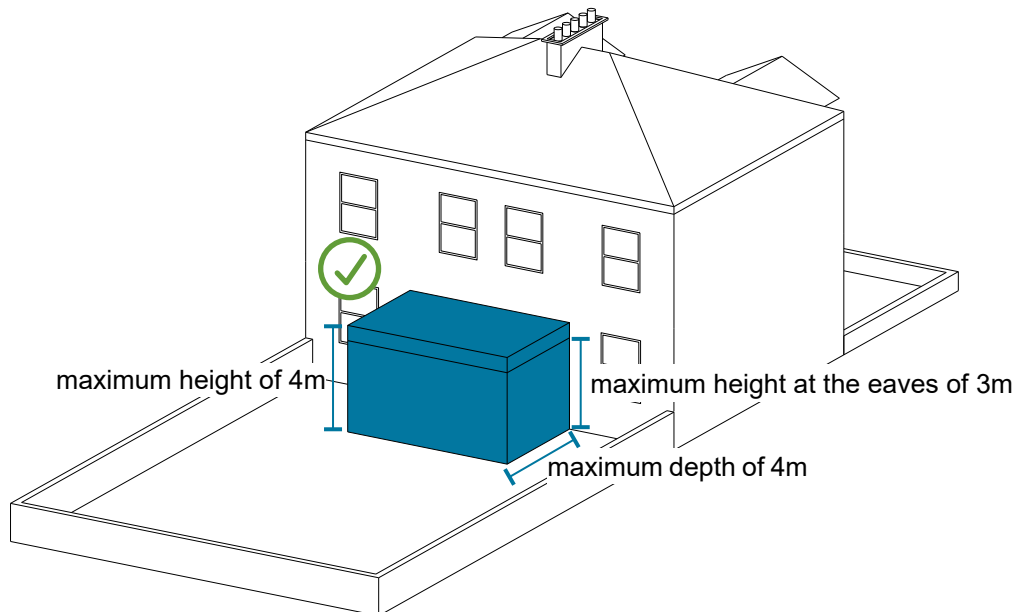

Figure 28: Rear extension at a detached house

3.5.2 Rear extensions requiring planning permission

Beyond permitted development, you will need planning permission. Planning permission is also required for rear extensions if your home is a flat/ maisonette or within a Conservation Area. It is also needed alongside Listed Building Consent for listed homes.

Extensions between 3m-6m in depth need to consider the impact that may be caused to any neighbours, especially if the extension is on the boundary wall. We also encourage the roof to be designed to slope down towards the neighbouring property and to remain below 2.4m at this boundary for the entire length of the extension.

Extensions which exceed 6m in depth on the boundary are likely to be refused. These generally lead to an increased sense of enclosure at neighbouring properties, also reducing their access to daylight and sunlight.

Rear extensions must also not take up more than 50% of the total rear garden space at your home.

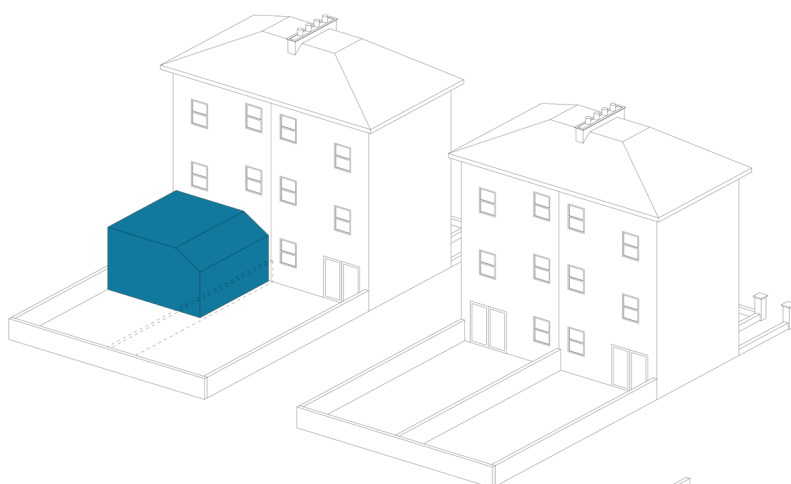

Recommended dimensions of rear extensions needing planning permission:

- maximum height of 4m
- depth below 6m
- maximum height of sloped down part 2.4m

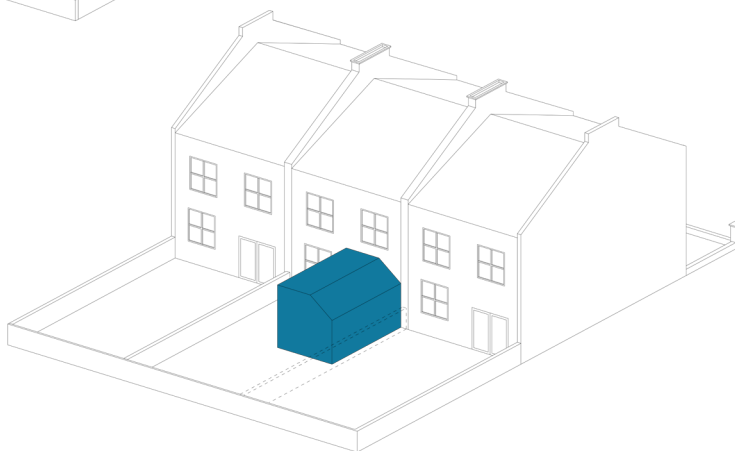

Figure 29: Rear extensions requiring planning permission

3.5.3 L-shaped or wrap around extensions

If your home includes an outrigger to the rear, as many traditional buildings in Southwark do, you may find the most appropriate solution is a L-shaped or wrap-around extension, as set out in [Figure 31](#).

Outriggers generally have a window at the rear and care should be taken to ensure any proposed extension does not close off this source of light. A courtyard may need to be created within the extension to avoid blocking light to a room and to allow ventilation, as set out in [Figure 31](#).

Wrap around extensions should remain no deeper than 6m on the boundary and stay below 2.4m at the eaves. The extension must also not take up more than 50% of the total rear garden space at your home.

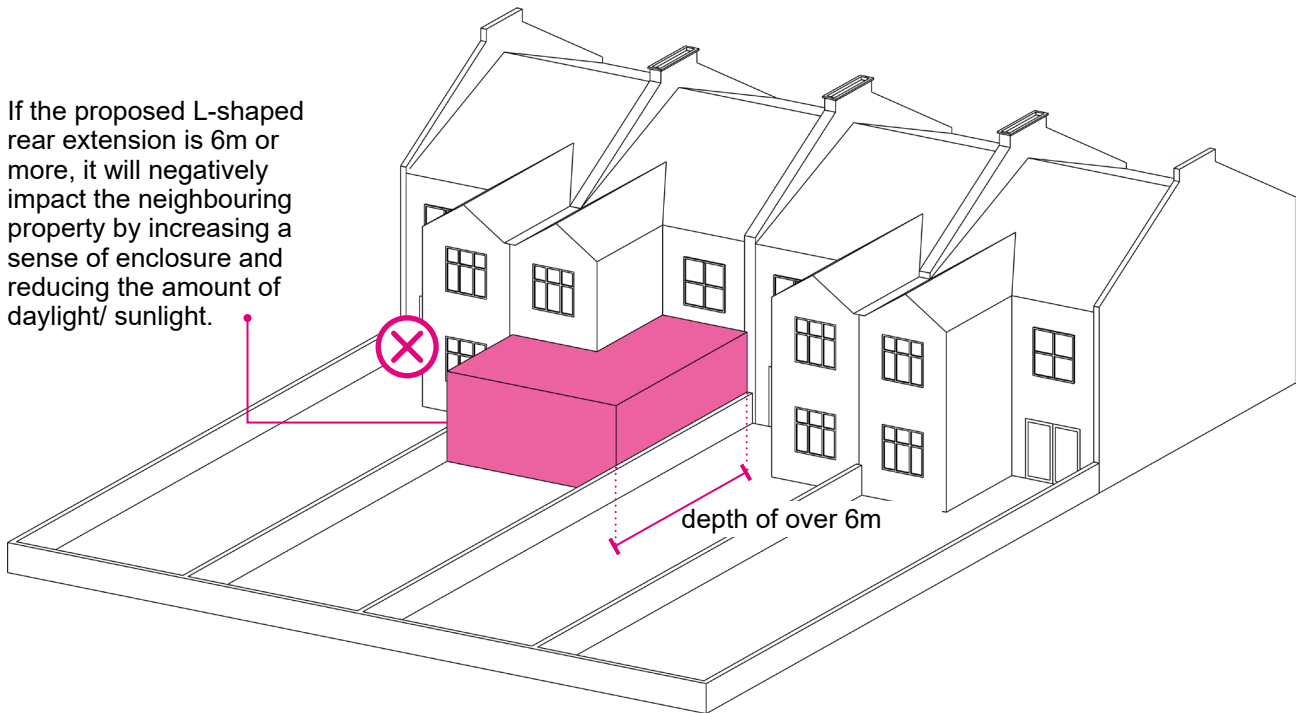

Figure 30: L-shaped or wrap around extension - poor example

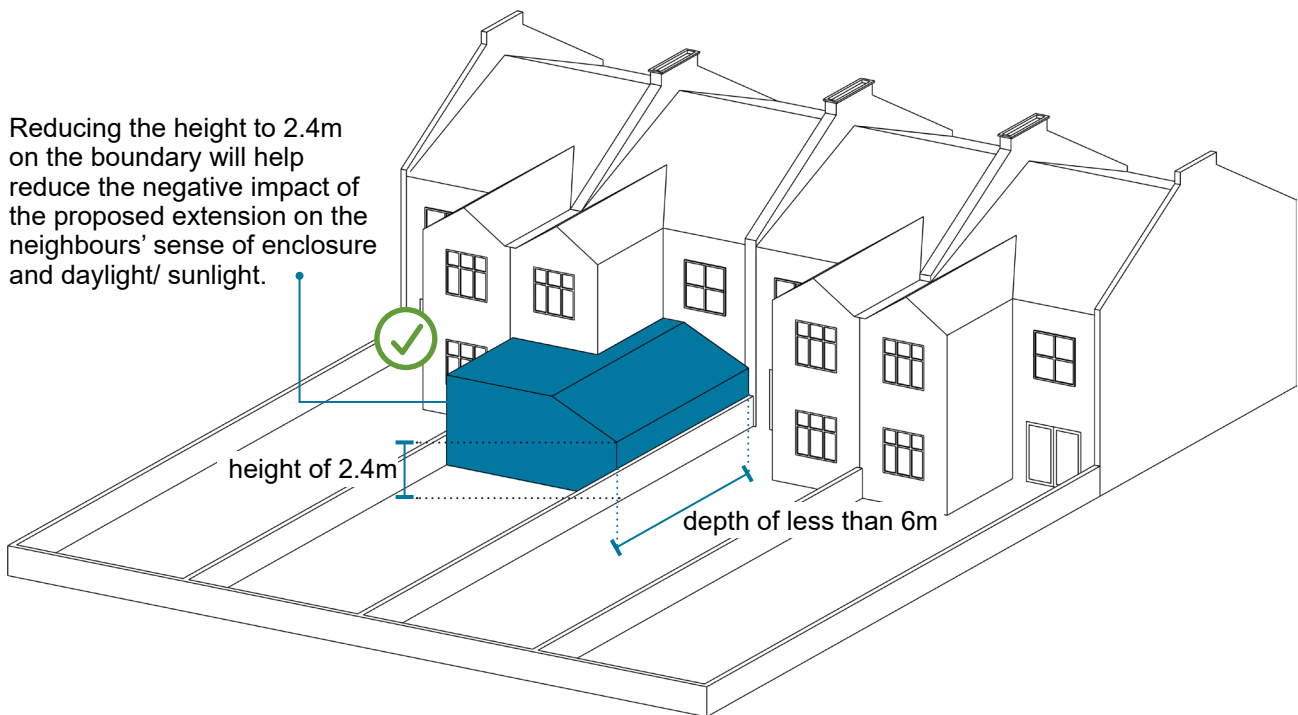

Figure 31: L-shaped or wrap around extension - good example

3.6 Roof extensions

Is permission required for a roof extension?

Houses	Flats/Maisonettes	Conservation Area	Listed Buildings
Permitted development applies within certain dimensions and roof works. Beyond this, Planning Permission will be required.	Planning Permission will be required.	Planning Permission will be required.	Listed Building Consent and Planning Permission will be required.

Table 15: 'Is permission required for a roof extension?'

Additional space can also be created at your home by extending your existing roof. There are two main types of roof extensions; mansard and dormer. You can also extend your roof by raising the ridge. Any extension which exceeds the highest part of the roof at your home will require planning permission. Roof extensions should remain subservient in scale to your existing home and not appear as a dominating feature.

3.6.1 Permitted development rear dormers

Permitted development allows you to extend your roof with a dormer up to 40 cubic m if a terraced property and 50 cubic m if it's a semi-detached or detached property. This is not applicable to homes which are flats, maisonettes, in a Conservation Area or listed.

The dormer extension should not be on the street facing roof slope and should not be taller than the highest part of the roof which is generally the ridge. It should be set back, as far as is practicable, at least 20cm from the original eaves. The 20cm distance is measured along the roof plane. The roof enlargement also cannot overhang the outer face of the wall of the original house.

3.6.2 Rear dormers requiring planning permission

Beyond permitted development, you will need planning permission. Planning permission is also required for rear extensions if your home is a flat / maisonette or within a Conservation Area. It is also needed alongside Listed Building Consent for listed homes.

Dormer extensions should sit within the existing roof and should not dominate the existing roof form.

Rear dormers should also be:

- symmetrically located
- at least 0.5m below the ridge of the roof
- 1m above the eaves
- set in 1m from shared boundary and from the edge of the roof.

Overly large or box dormers will not be permitted in Conservation Areas or for Listed Buildings. These are not seen as sympathetic to the historic character of these homes.



The dormer roof extension dominates the roofscape. It occupies the full width, depth and height of the existing roof. This is not acceptable.



- Dormer extensions are confined to the rear elevation.
- It should be designed to sit within the existing roofscape, i.e. set in at a minimum of 0.5m from the gutterline and 0.5m from the ridge.



In conservation areas, rear box dormers should be designed to sit *well* within the original roof slope.

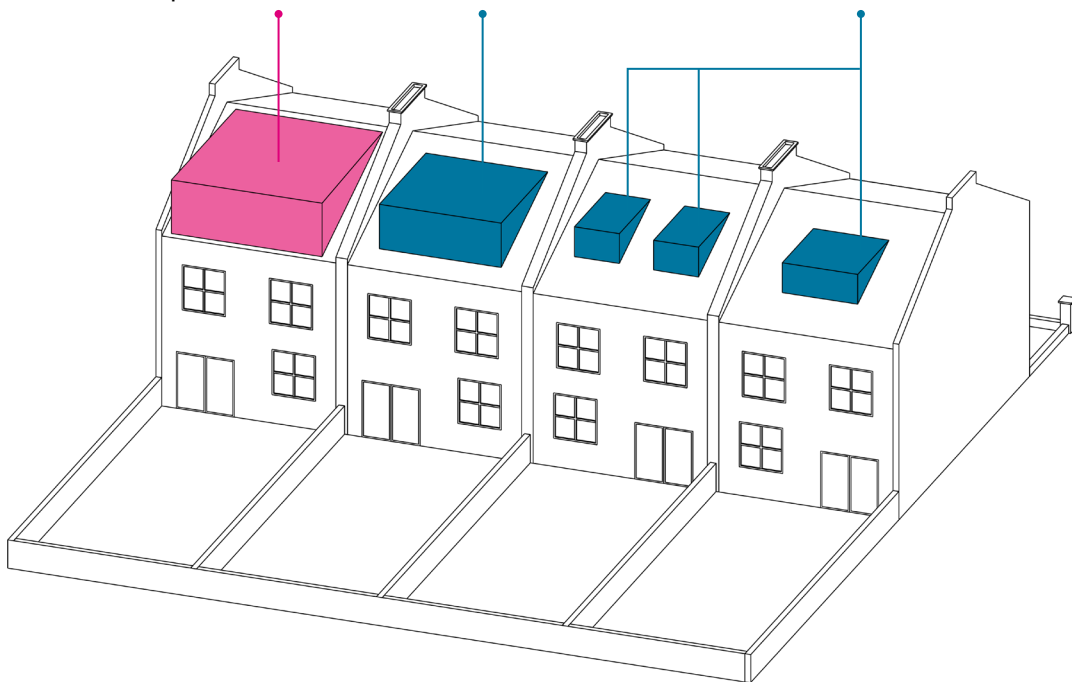

Figure 32: Rear dormers

3.6.3 Side dormers

Side dormers are not encouraged, unless they are an original or common feature of properties in that street. Side dormers should sit within the slope of the roof, well clear of any hips and verges.

3.6.4 Mansard extensions

All mansard extensions will require planning permission.

Mansard extensions should be designed to sit behind the front and rear parapet and should be at a maximum angle of 70 degrees. If your home is located on a street corner, the mansard should return to match the parapet. Mansard extensions will not be permitted if extending onto an outrigger.

A mansard extension will also not be permitted if disrupting the consistency of surrounding roof forms. For example, a mansard extension would not be permitted where there is an unbroken run of butterfly roofs, as set out in [Figure 34](#).

Windows should follow the alignment and design of the existing windows on the upper floors of the house at the front and rear and should be designed as discrete dormer windows set within the roof-slope.

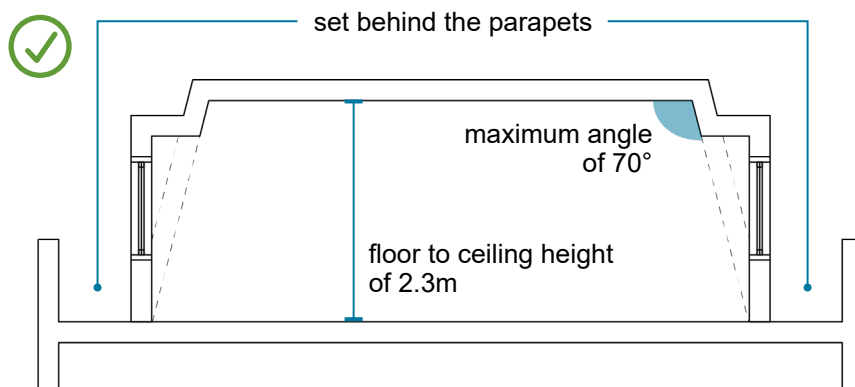

Figure 33: Mansard extension - good example

Where there is a terrace of an unbroken run of butterfly roofs, alteration to the roofscape to create a mansard extension will not be supported.

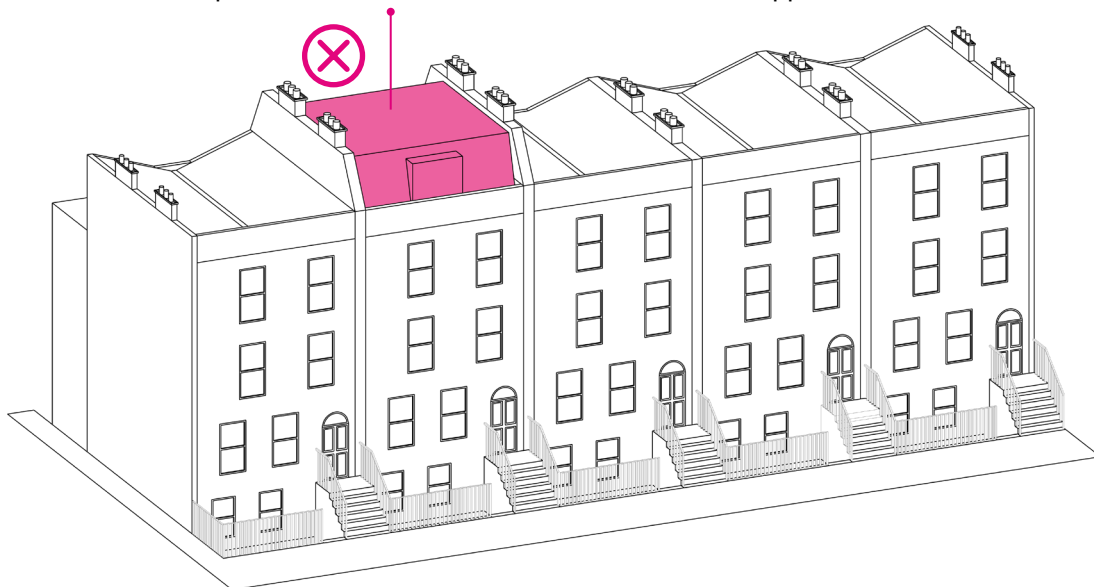

Figure 34: Mansard extension in an unbroken run of butterfly roofs - bad example

3.6.5 Ridge raises

Raising the roof ridge at your home will require planning permission. Listed Building Consent would also be required if your home is listed.

The ridge is the highest part of the roof and the line running the length of the roof, where the two roof slopes meet.

Ridge raises should be designed so that the slope of the front/street facing roof remains the same, as illustrated in **Figure 35**. To raise the ridge the front roof slope should be extended upwards, by no more than 300-400mm, with the gradient unaltered. The ridge raise should be accommodated within any roof chimneys and not visible beyond this. The ridge raise should also use like-for-like materials with the existing roof.

This is to ensure the ridge raise does not change the appearance of the roof from the street, and consistent rooflines are maintained in the area. This is especially important where there is a strong uniformity in roof forms or for homes which are listed or within Conservation Areas.

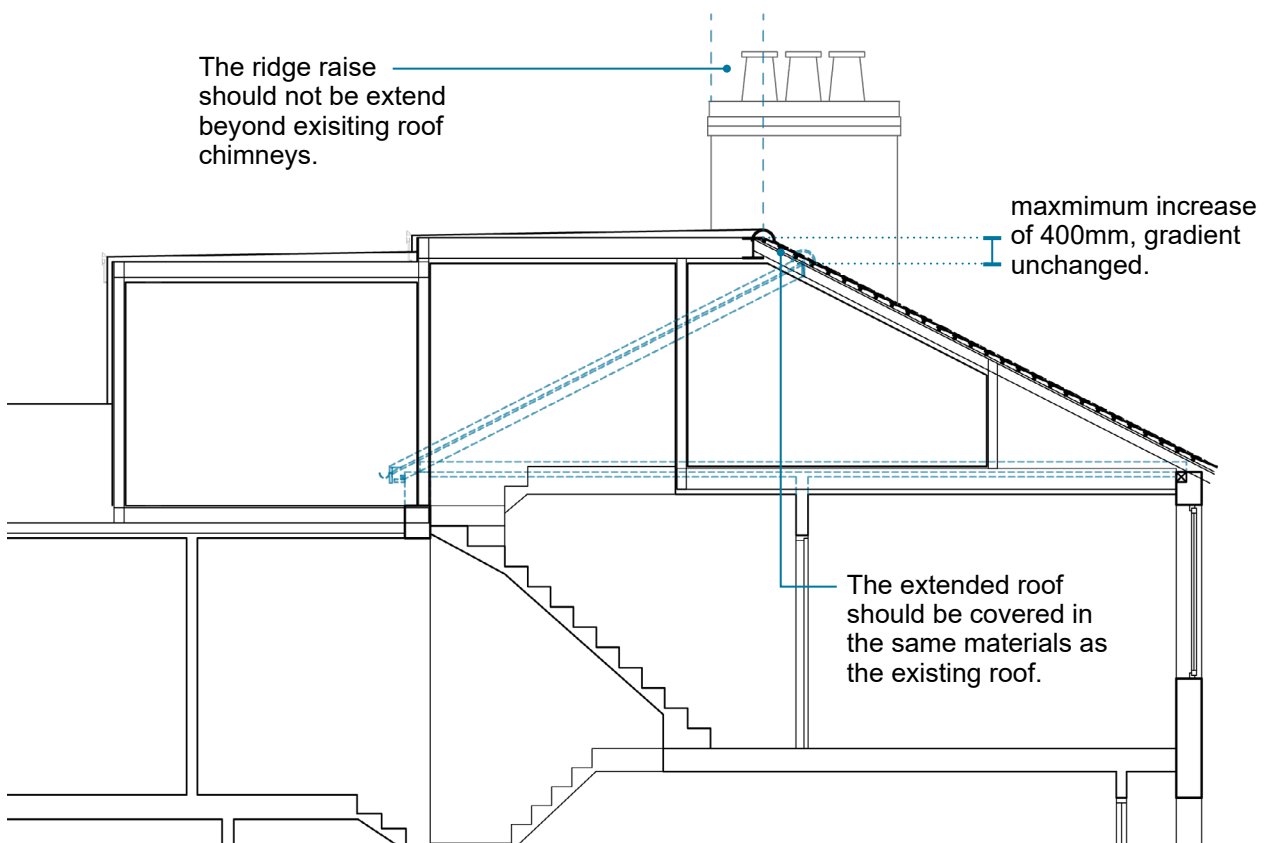

Figure 35: Ridge raise

3.6.6 Rooflights

Rooflights are a useful way to bring light and ventilation into your home and can have make a loft space more habitable.

Permitted development allows householders to install rooflights on street-facing roof slopes provided they are not more than 0.15m above the roof plane.

The size and number of rooflights should not dominate the existing roof. Rooflights are encouraged to be installed with a neat arrangement.

Within Conservation Areas, rooflights should sit flush with the roof slope and should not extend beyond the roof slope. Conservation style rooflights are also required to be used.

3.6.7 Terraces

Terraces can provide valuable amenity space, especially for flats that would otherwise have little or no private outside space. You need to consider the impact of a roof terrace on the amenity of your neighbours. Terraces can generate harmful noise disturbance and issues of overlooking to your neighbours when in use. The terrace should be setback to reduce the impact on your neighbours.

Where terraces allow for direct views into neighbouring properties, privacy screening should be used. Privacy screening should be no less than 1.8m in height. Perforated screening is preferred, but obscured glazing can also be used.

If proposing a balcony to sit within the existing roof, the existing parapet should be maintained, and any required screening should sit behind.

- Roof terraces should be designed to ensure they do not negatively affect daylight/ sunlight or privacy by way of overseeing neighbouring properties.
- They should be set back by at least 1.5m from the rear elevation and 1m from the side edges.
- A screening would be required to help restrict views out to preserve the amenity of the neighbouring properties. The proposed screening would need to be 1.8m in height

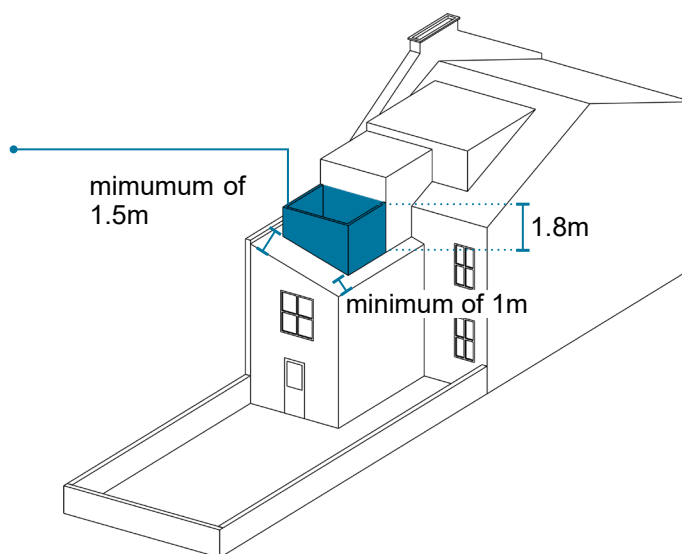

Figure 36: Roof terrace

3.7 Garden rooms and outbuildings

Is permission required for a garden room or outbuilding?

Houses	Flats/Maisonettes	Conservation Area	Listed Buildings
Permitted development applies within certain dimensions and roof works. Beyond this, Planning Permission will be required.	Planning Permission will be required.	Planning Permission will be required.	Listed Building Consent and Planning Permission will be required.

Table 16: 'Is permission required for a garden room or outbuilding?'

Garden rooms and outbuildings can provide useful additional space for your home. Within certain limitations permitted development will allow the installation of a garden room without requiring planning permission.

Where planning permission is required, we encourage garden rooms to have a depth of 3m, width of 5m, height of 4m with a height of 2.5m at the eaves at the maximum. This is to ensure that garden rooms remain subservient to the main building. The outbuilding also needs to be set in from the boundaries of neighbouring properties by 2m.

Garden rooms must also not take up more than 50% of the total rear garden space at your home.

Garden rooms should be designed as ancillary spaces to enhance the enjoyment of your home, and not create a new dwelling. This means the garden room should be accessed from within your existing garden, and not from a separate entrance. There should also be minimal plumbing or other services to the garden room. We may impose a planning condition or require a legal agreement to limit the use of any garden room in line with this.

Consideration also needs to be given to the impact a garden room may have on existing trees or root areas.

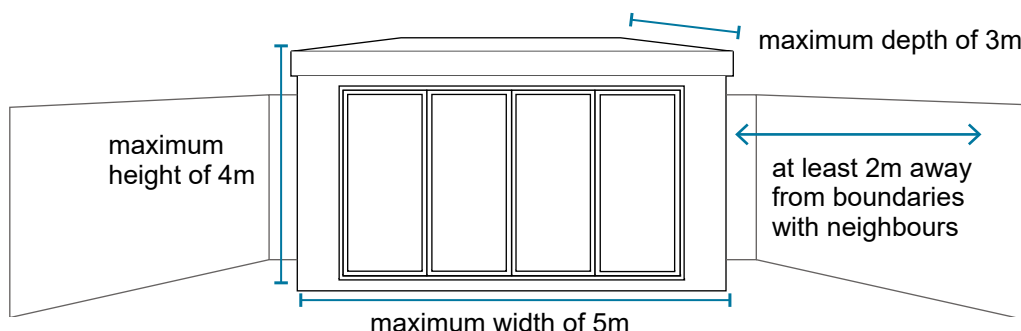

Figure 37: Garden room or outbuilding

3.8 Basement extensions

Is permission required for a basement extension?

Houses	Flats/Maisonettes	Conservation Area	Listed Buildings
Planning Permission will be required.	Planning Permission will be required.	Planning Permission will be required.	Listed Building Consent and Planning Permission will be required.

Table 17: 'Is permission required for a basement extension?'

Basement extensions create an opportunity to increase the footprint of your home. Planning permission is required for all homes to create a new or extend an existing basement. Listed Building Consent would also be required if your home is listed.

A Basement Impact Assessment (BIA) will need to be submitted alongside your application. The purpose of a BIA is to assess the impact of the development on your home, your neighbours and the environment.

You will need to submit a Flood Risk Assessment alongside your application if your home is located within a flood risk area. An Archaeological Assessment will also be required for homes within Archaeological Priority Areas and Sites of Archaeological Importance. You can check if your home is within any of these areas on Southwark Maps.

Basement extensions should not extend into or underneath the rear garden, from the principal rear wall to a depth of more than 50% of the garden. The extension should not extend to the front of the property to a depth of more than 30%. Basement extensions are also limited to no more than a single storey below ground.

Basement extensions should not dominate or result in an unacceptable loss of garden area at your home. You will also need to consider the existing trees at your home and your neighbours.

Basement rooms are encouraged for storage or utility rooms. Habitable rooms (such as living rooms or bedrooms) will only be permitted where it can be demonstrated there is sufficient access to light and ventilation and no flood risk.

3.8.1 Lightwells

Lightwells are common elements that form part of basements. Lightwells can allow better light and outlook into basements which would otherwise be of poor quality.

A Lightwell will only be permitted where already a common feature in a street or area. Lightwells may be discreetly located to the rear of the property as this would not be visible from the public domain.

- To ensure adequate levels of daylight/ sunlight, the 25-degree test should be applied.
- Draw a line at 25 degrees upwards from the centre of the affected window.

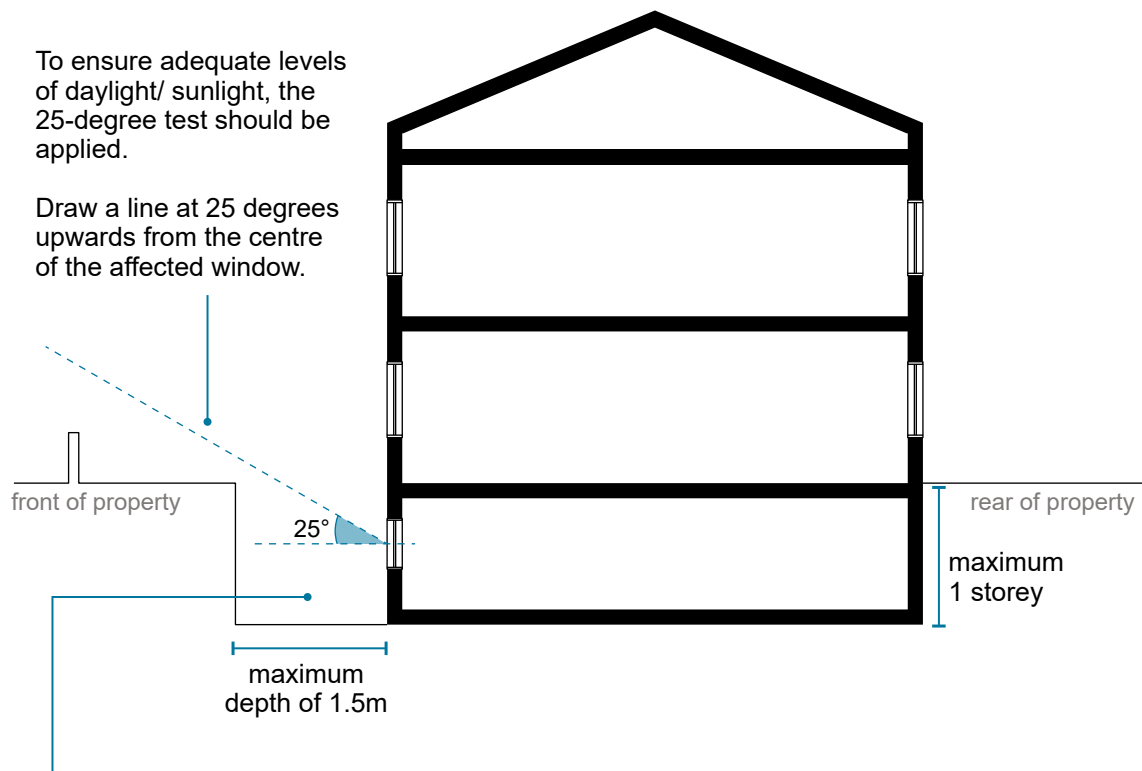

- Lightwells can be used to provide basement extensions with adequate levels of daylight/ sunlight and ventilation.
- They should have a maximum depth of 1.5m.

Figure 38: Lightwells

GLOSSARY

GLOSSARY

Active design: A concept that concerns how the design of buildings and streets can help people to lead more physically active and healthy lives.

Air source heat pump (ASHP): A device that transfers heat from the outside air to water. This in turn heats your rooms via radiators or underfloor heating. It can also heat water stored in a hot water cylinder for your hot taps, showers and baths.

Amenity: A positive element or elements that contribute to the overall character or enjoyment of an area. For example, open land, trees, historic buildings and the inter-relationship between them, or less tangible factors such as tranquillity.

Archaeology: Archaeology refers to buried archaeological finds, layers and features which are buried below the ground and not visible.

Architectural integrity: Architectural elements, materials, colour, and quality of the original building construction.

Architectural interest: In listed buildings this refers to buildings that are important to the nation because of their architectural design, decoration and craftsmanship. Important examples of significance include plan forms, particular building types and techniques such as using cast iron, the early use of concrete and early prefabricated buildings.

Arrangement: Arrangement refers to how the key frames are arranged in a window or door.

Article 4 Direction: A direction made under Article 4 of the Town and Country Planning (General Permitted Development) (England) Order 2015 which withdraws permitted development rights granted by that Order.

Balustrade: A railing or wall on a balcony or staircase, supported by balusters (short decorative pillars).

Basement Impact Assessment (BIA): A technical report that assesses the impact of a proposed basement on the rest of the building, neighbouring properties and the environment.

Biodiversity: The variety of animal and plant life that exists in a certain place.

Brick slips: Specially manufactured tiles which when installed have the appearance, colour and texture of a real clay brick wall.

Built heritage: Built Heritage means all the heritage places and features that survive as buildings or structures above ground and are visible and visitable.

Butterfly roof: A roof with two roof surfaces sloping down from opposing edges to a valley near the middle of the roof.

Casement window: A window that is attached to its frame by one or more hinges at the side.

Cavity wall: A type of wall that has a hollow centre.

Certificate of Lawfulness: A formal confirmation from a local planning authority that on the date of issuing the Certificate the use of the land or the development of it is lawful.

Classified roads: Refers to A roads, B roads, as well as some classified un-numbered roads (known unofficially as C roads). By contrast, unclassified roads are local roads intended for local traffic.

Condition survey: A survey carried out by a professional to identify what work is needed to maintain a property and how much this might cost. This may include building structure, roofs, sewage and drainage, electrics, fire safety, asbestos etc.

Conservation: The process of maintaining and managing change to a heritage asset in a way that sustains and, where appropriate, enhances its significance.

Conservation Areas: These are areas of special architectural or historic interest whose character or appearance is protected. They have to be formally designated under the provisions of the Planning (Listed Buildings and Conservation Areas) Act 1990.

Context: Context refers to the setting of a site or area, including factors such as townscape, built form, land use, activities, heritage and vehicular and pedestrian movement.

Cornice: A decorative feature in the corner of a room where the walls and ceiling meet.

Crittall: A well-known manufacturer of steel doors, windows and internal screens.

Depth of reveal: The distance between the outer edge of the window or door frame and the interior wall surface.

Dormer: A window that projects vertically from a sloping roof.

Double Glazing: Windows that have two panes of glass, separated by a sealed gap, which reduces heat transfer.

Eaves: The part of a roof that meets or overhangs the walls of a building.

Elevation: A side of a building.

Fenestration: The arrangement of windows in a building.

Flush: Completely level or even with another surface.

Gable: The triangular upper part of a wall at the end of a ridged roof.

Gable roof: A roof with at least one flat end.

Glazing bars: Rigid bars that connect two separate panes of glass.

Glazing type: Glazing type refers to whether a window or door is single, double or triple glazed.

Green infrastructure: A network of habitats which is often multifunctional and can provide a range of benefits to improve mental health, active lifestyles, recreation, food growing, enhanced biodiversity and ecological resilience, flood risk management, temperature regulation and improved air and water quality.

Ground source heat pump (GSHP): A device that transfers heat from the ground outside your home to heat your radiators or underfloor heating. It can also heat water stored in a hot water cylinder for your hot taps and showers.

Habitable room: A room that provides living accommodation, such as a bedroom, living room, dining room, study or conservatory. Bathrooms, kitchens that do not include dining space, storerooms and utility rooms are not habitable rooms.

Harm: Harm in planning terms means something that may damage a heritage asset or result in a loss of significance.

Heritage: Heritage includes all inherited resources which people value for reasons beyond mere utility. These are cultural inherited assets which people identify and value as a reflection and expression of their evolving knowledge, beliefs and traditions, and of their understanding of the beliefs and traditions of others.

Heritage asset: A building, monument, site, place, area or landscape identified as having a degree of significance meriting consideration in planning decisions, because of its heritage interest.

Hip: The sharp edge of a roof from the ridge to the eaves where the two sides meet.

Hip roof: A type of roof where all sides slope downwards to the walls, usually with a fairly gentle slope.

Historic environment: A very general term used to refer to everywhere around us that has something significant about it. It is defined by the NPPF as: 'all aspects of the environment resulting from the interaction between people and places through time, including all surviving physical remains of past human activity, whether visible, buried or submerged and landscaped and planted or managed flora.'

Historic integrity: The ability of a building to convey its historic significance, including materials, design, feeling, location, association, workmanship, and setting.

Historical interest (buildings): This refers to buildings that have important aspects of the nation's social, economic, cultural or military history, such as industrial buildings, railway stations, schools, hospitals, theatres, and town halls.

In situ: In the original place.

Joinery: Wooden components (e.g. of a window frame).

Lawful Development Certificate: See Certificate of Lawfulness.

Lightwell: A shaft or open space that lets light into a building, often the basement.

Listed Building: A building or structure which is considered to be of 'special architectural or historic interest'. This includes a wide variety of structures and buildings. There are three grades of listing depending on the importance of the building.

Listed Building Consent: Permission that must be obtained from the Council for any works to a listed building that would affect its special architectural or historic interest.

Locally Listed Building: A building, structure or feature which is not statutorily listed but is important in the local context owing to its special architectural or historic interest or its townscape or group value. The protection of local heritage is important because it enhances the value of Southwark's built environment, but also maintains a sense of local distinctiveness which can assist with regeneration and place-making.

London Plan: The London Plan 2021 is the Spatial Development Strategy for Greater London. It sets out a framework for how London will develop over the next 20-25 years.

Maisonette: A two-storey flat with its own front door.

Mansard extension: A way of adding extra space to a house by building a mansard roof, effectively adding an extra floor to the property.

Mansard roof: A mansard roof is a type of roof which combines elements of a gambrel roof and a hip roof. Like a gambrel roof, a mansard roof has two slopes on each side, with the upper being less steep and shorter than the lower slope. Unlike a gambrel roof, however, a mansard roof has slopes on all four sides.

Massing: Massing refers to the combined effect of the height, bulk and silhouette of a building or group of buildings.

National Planning Policy Framework (NPPF): The NPPF sets out government's planning policies for England and how these are expected to be applied.

Net zero (carbon): Activity that causes no net release of carbon dioxide and other greenhouse gas emissions into the atmosphere.

Obscure glazing / obscure glass: Glass that is patterned or frosted to reduce transparency, meaning you cannot see through it clearly.

Outbuilding: A smaller separate building such as a shed that belongs to a main building, such as a house

Outlook: A view (out of a window).

Outrigger: The part of a terraced house, usually incorporating the kitchen area, that projects out of the back of the house. These are common in Victorian and Edwardian homes built in London, including in Southwark.

Parapet: A low protective wall along the edge of a roof, bridge, or balcony.

Party wall: A wall shared by two adjacent properties.

Permitted development: Development that does not require planning permission to be carried out.

Photovoltaic panels (PVs): Solar panels that generate electricity (as opposed to solar thermal panels, which are used to provide hot water).

Rafter: A rafter is a structural component used in the construction of a roof. It is a sloping beam that supports the weight of the roof and transfers it to the walls or other supporting structures of a building.

Render: A first coat of plaster applied to a brick or stone surface.

Ridge: The line or edge formed where the two sloping sides of a roof meet at the top.

Sash window: A window that slides open vertically or horizontally, rather than using a hinge.

Reveal: The portion of a wall opening that is exposed when a window or door is installed. It is the area between the outer edge of the window or door frame and the adjacent wall surface.

Rooflight: A window built into a roof.

Scheduled monument: A nationally important historic building (or archaeological site) that is protected against unauthorised change.

Secondary glazing: The installation of a separate internal window on the inside of the existing window. This replicates the airtight seal and insulation gap offered by double glazing.

Shingles: A roof covering consisting of individual overlapping tiles.

Streetscape: The appearance or design of a street.

Stucco: A cement-type mixture made of Portland cement, lime, sand and water. It is a thin finish coat that goes on the outermost layer of buildings.

Stud wall: A partitioning wall made from a stud (timber) frame with plasterboard nailed over the top.

Supplementary Planning Documents (SPDs): SPDs explain how current planning policies in the Local Plan will be applied. They also contain background information applicants may find useful when preparing their planning applications.

Sympathetic: Designed in a sensitive and appropriate way (in relation to the wider building or streetscape).

Thermal performance: Thermal performance means how well a building retains heat.

Tree Protection Order (TPO): An order made by a local planning authority in England to protect specific trees, groups of trees or woodlands in the interests of amenity.

Townscape: The visual appearance of an urban area.

U-value: A useful metric to compare different insulating products. It indicates how much heat is lost through a given thickness of material, accounting for conduction, convection and radiation. The lower the U-value, the better the material is as a thermal insulator. Part L of the Building Regulations includes target U-values for domestic properties.

Vehicle crossover: A Vehicle crossover, also known as a Dropped or Lowered Kerb, provides the legal means for motor vehicles to access a property. To create a vehicle crossover, a section of kerb is lowered (known as a 'dropped kerb') and a driveway is created linking the road to property, and/or a site.

Ventilation: The provision of fresh air to a room or building.

Verge: The edge of tiles projecting over a gable.

Visual impact assessment (VIA): A visual impact assessment illustrates how the proposed works would appear on your home and in views from the surrounding area. The assessment should be proportionate to the scale of the works, sensitivity of the property and its location (whether it is listed or in a conservation area, or panels are public facing).

